



TECNITANQUES
GLOBAL INFRASTRUCTURE DEVELOPMENT



**Puerto
de Santa Marta**
Sociedad Portuaria

ESTACIÓN CC - LINK SA13-T7D (TR22)

4				FECHA:	17/Mar/2020	 TEL: (+57 4) 4 44 74 41 Cr. 48C # 100 Sur - 72 La Estrella - Antioquia www.elicogrp.com	CONTIENE:	PORTADA	IMPRESO: 20 marzo 2020	
3				DISEÑO:	L.F.G.G.				IT1 - PORTADA	
2				DIBUJÓ:	L.F.G.G.				ANTERIOR:	#ORDEN: 0120004
1				REVISÓ:	J.D.A.H			PROYECTO:	AUTOMATIZACIÓN SILOS	ESQUEMA: IT1
REV.	DESCRIPCIÓN	FECHA	NOMBRE	APROBÓ:	J.D.A.H		CLIENTE:	SOCIEDAD PORTUARIA SANTA MARTA	SIGUIENTE: J1	TOTAL HOJAS: 020

A

B

C

D

E

F

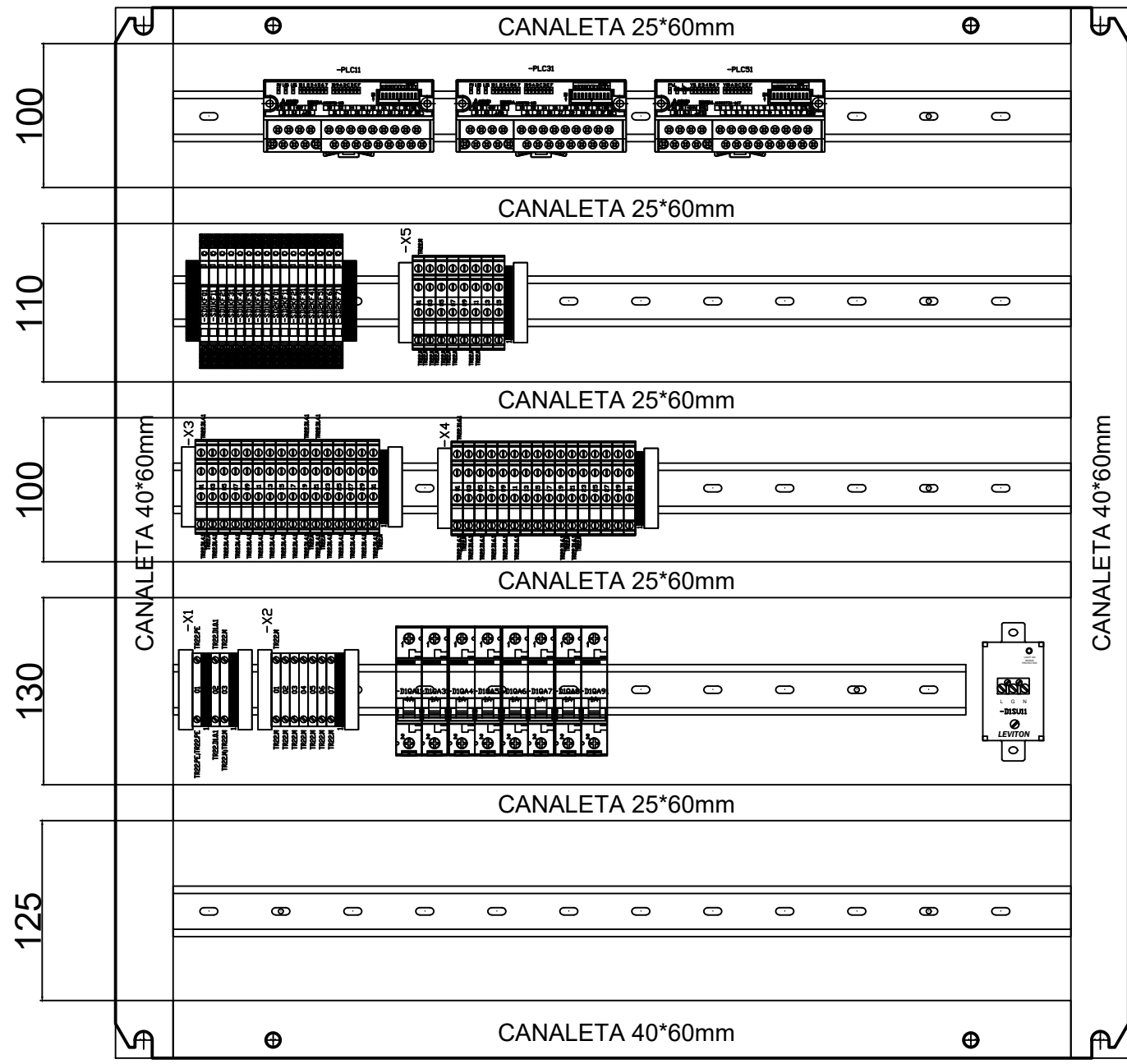

4				FECHA:	17/Mar/2020
3				DISEÑO:	L.F.G.G.
2				DIBUJÓ:	L.F.G.G.
1				REVISÓ:	J.D.A.H
REV.	DESCRIPCIÓN	FECHA	NOMBRE	APROBÓ:	J.D.A.H

ElicoGroup
 TEL: (+57 4) 4 44 74 41
 Cr. 48C # 100 Sur - 72
 La Estrella - Antioquia
 www.elicogrp.com

CONTIENE:	DISTRIBUCIÓN DOBLE FONDO
PROYECTO:	AUTOMATIZACIÓN SILOS
CLIENTE:	SOCIEDAD PORTUARIA SANTA MARTA

IMPRESO:	20 marzo 2020
J1- DISTRIBUCIÓN DOBLE FONDO	
ANTERIOR:	IT1
ESQUEMA:	J1
SIGUIENTE:	D1
#ORDEN:	OI20004
#REVISIÓN:	1
TOTAL HOJAS:	20

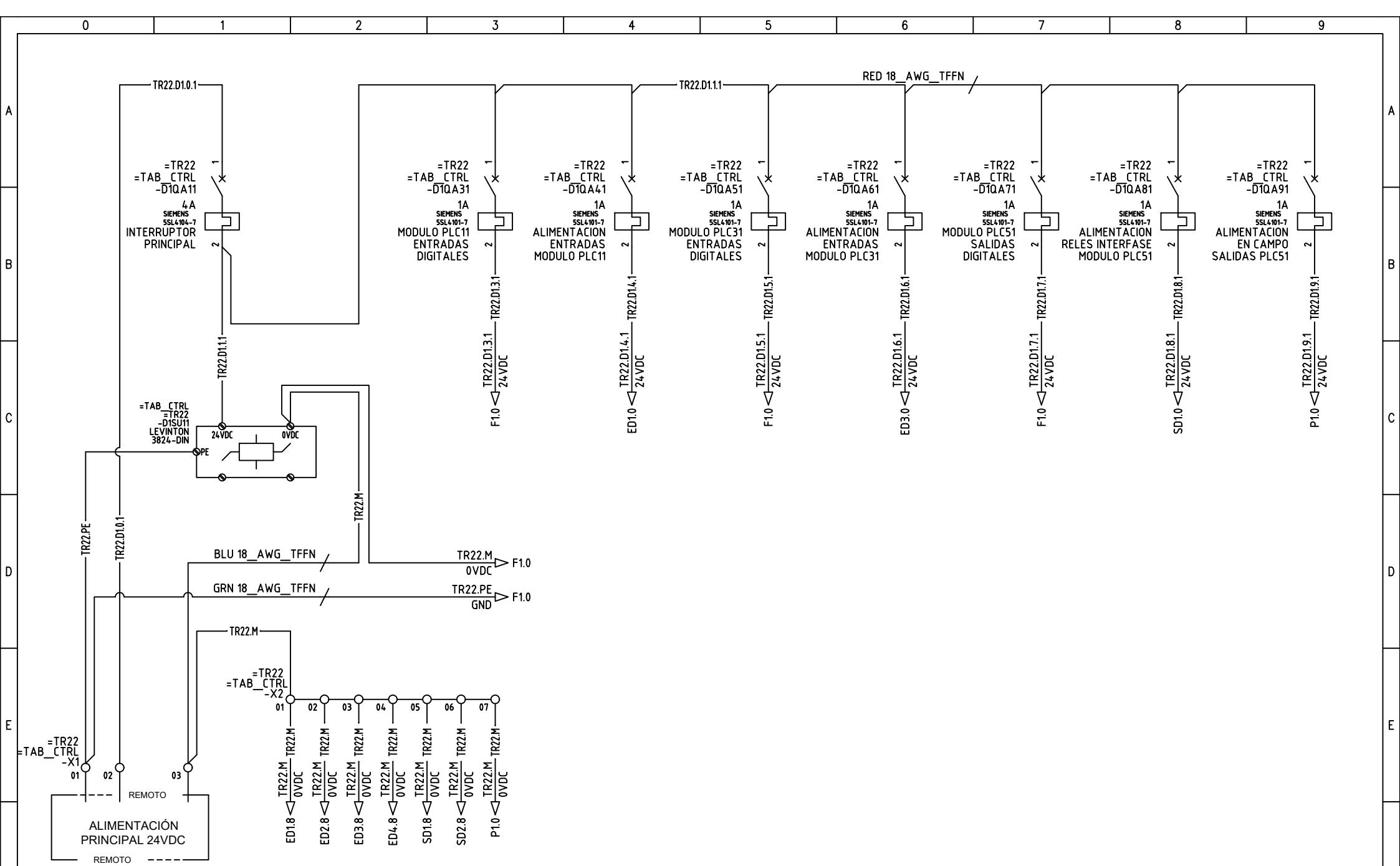

4				FECHA:	17/Mar/2020
3				DISEÑO:	L.F.G.G.
2				DIBUJÓ:	L.F.G.G.
1				REVISÓ:	J.D.A.H
REV.	DESCRIPCIÓN	FECHA	NOMBRE	APROBÓ:	J.D.A.H

ElicoGroup
 TEL: (+57 4) 4 44 74 41
 Cr. 48C # 100 Sur - 72
 La Estrella - Antioquia
 www.elicogrp.com

CONTIENE:	ALIMENTACIÓN PRINCIPAL 24VDC
PROYECTO:	AUTOMATIZACIÓN SILOS
CLIENTE:	SOCIEDAD PORTUARIA SANTA MARTA

IMPRESO:	20 marzo 2020
D1- ALIMENTACIÓN PRINCIPAL	
ANTERIOR:	J1 #ORDEN: OI20004
ESQUEMA:	D1 #REVISIÓN: 1
SIGUIENTE:	F1 TOTAL HOJAS: 20

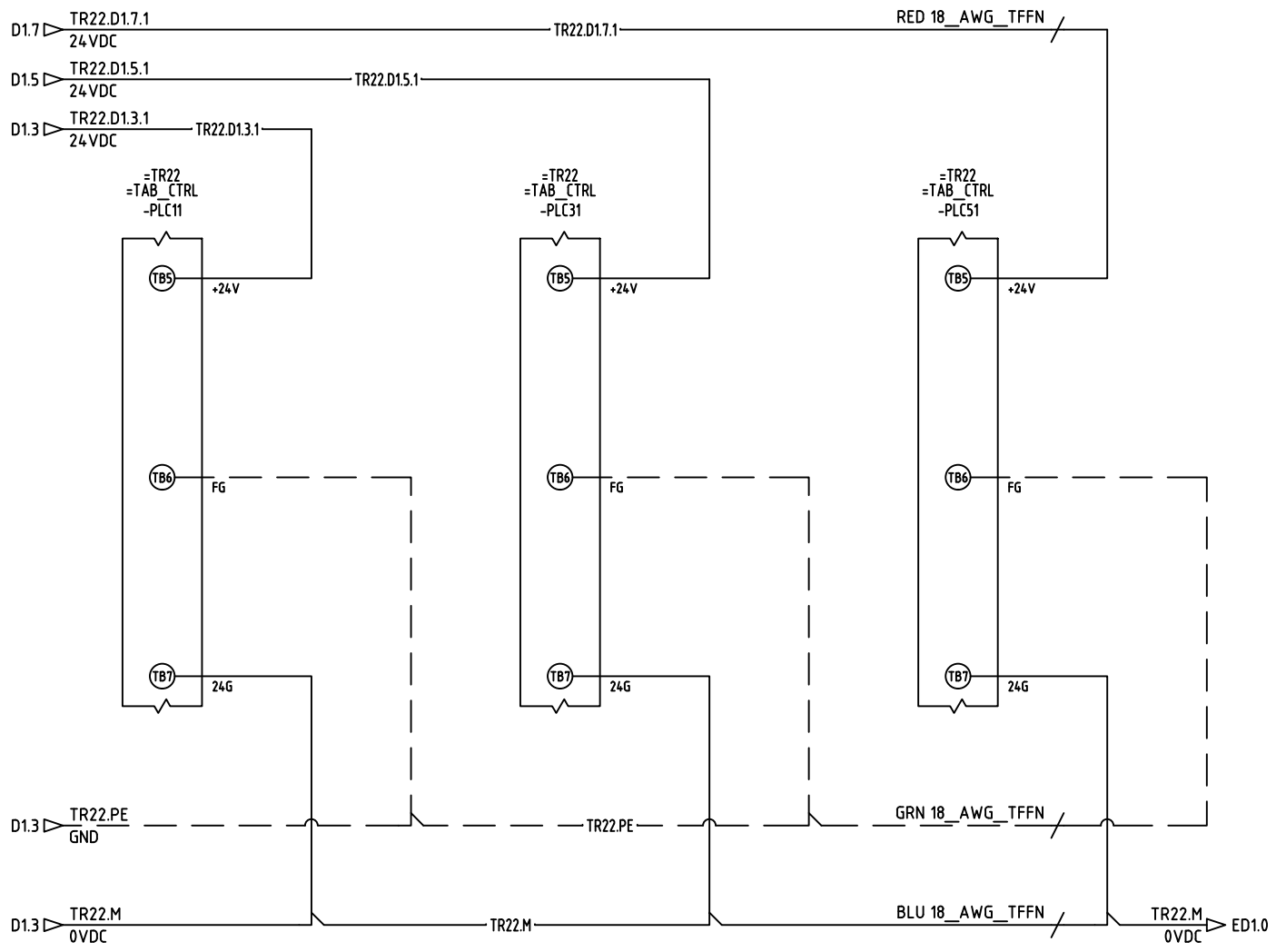

4				FECHA:	17/Mar/2020
3				DISEÑO:	L.F.G.G.
2				DIBUJÓ:	L.F.G.G.
1				REVISÓ:	J.D.A.H
REV.	DESCRIPCIÓN	FECHA	NOMBRE	APROBÓ:	J.D.A.H



 TEL: (+57 4) 4 44 74 41
 Cr. 48C # 100 Sur - 72
 La Estrella - Antioquia
www.elicogrp.com

CONTIENE:	DISTRIBUCIÓN HARDWARE MÓDULOS PLC
PROYECTO:	AUTOMATIZACIÓN SILOS
CLIENTE:	SOCIEDAD PORTUARIA SANTA MARTA

IMPRESO: 20 marzo 2020	
F1- DISTRIBUCIÓN HARDWARE PLC	
ANTERIOR: D1	#ORDEN: 0I20004
ESQUEMA: F1	#REVISIÓN: 1
SIGUIENTE: G1	TOTAL HOJAS: 20

=TR22
=TAB_CTRL
=MITSUBISHI
=AJ65BTB1-16D
ENTRADAS DIGITALES
24VDC SINK/SOURCE INPUTS

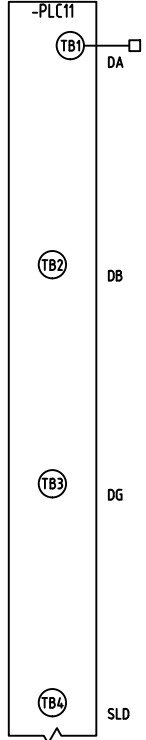

=TR22
=TAB_CTRL
=MITSUBISHI
=AJ65BTB1-16D
ENTRADAS DIGITALES
24VDC SINK/SOURCE INPUTS

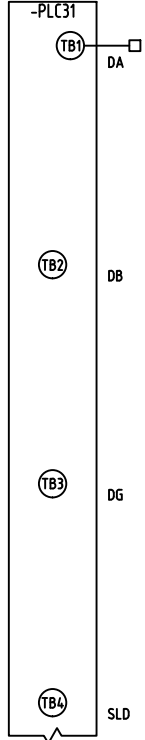

=TR22
=TAB_CTRL
=MITSUBISHI
=AJ65BTB1-16T
SALIDAS DIGITALES
12/24VDC OUTPUTS

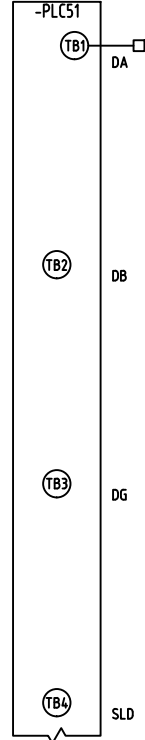

4				FECHA:	17/Mar/2020
3				DISEÑO:	L.F.G.G.
2				DIBUJÓ:	L.F.G.G.
1				REVISÓ:	J.D.A.H
REV.	DESCRIPCIÓN	FECHA	NOMBRE	APROBÓ:	J.D.A.H

ElicoGroup
TEL: (+57 4) 4 44 74 41
Cr. 48C # 100 Sur - 72
La Estrella - Antioquia
www.elicogrp.com

CONTIENE:	CONEXIÓN CC-LINK
PROYECTO:	AUTOMATIZACIÓN SILOS
CLIENTE:	SOCIEDAD PORTUARIA SANTA MARTA

IMPRESO: 20 marzo 2020	
G1- CONEXIÓN CC-LINK	
ANTERIOR: F1	#ORDEN: 0120004
ESQUEMA: G1	#REVISIÓN: 1
SIGUIENTE: ED1	TOTAL HOJAS: 20

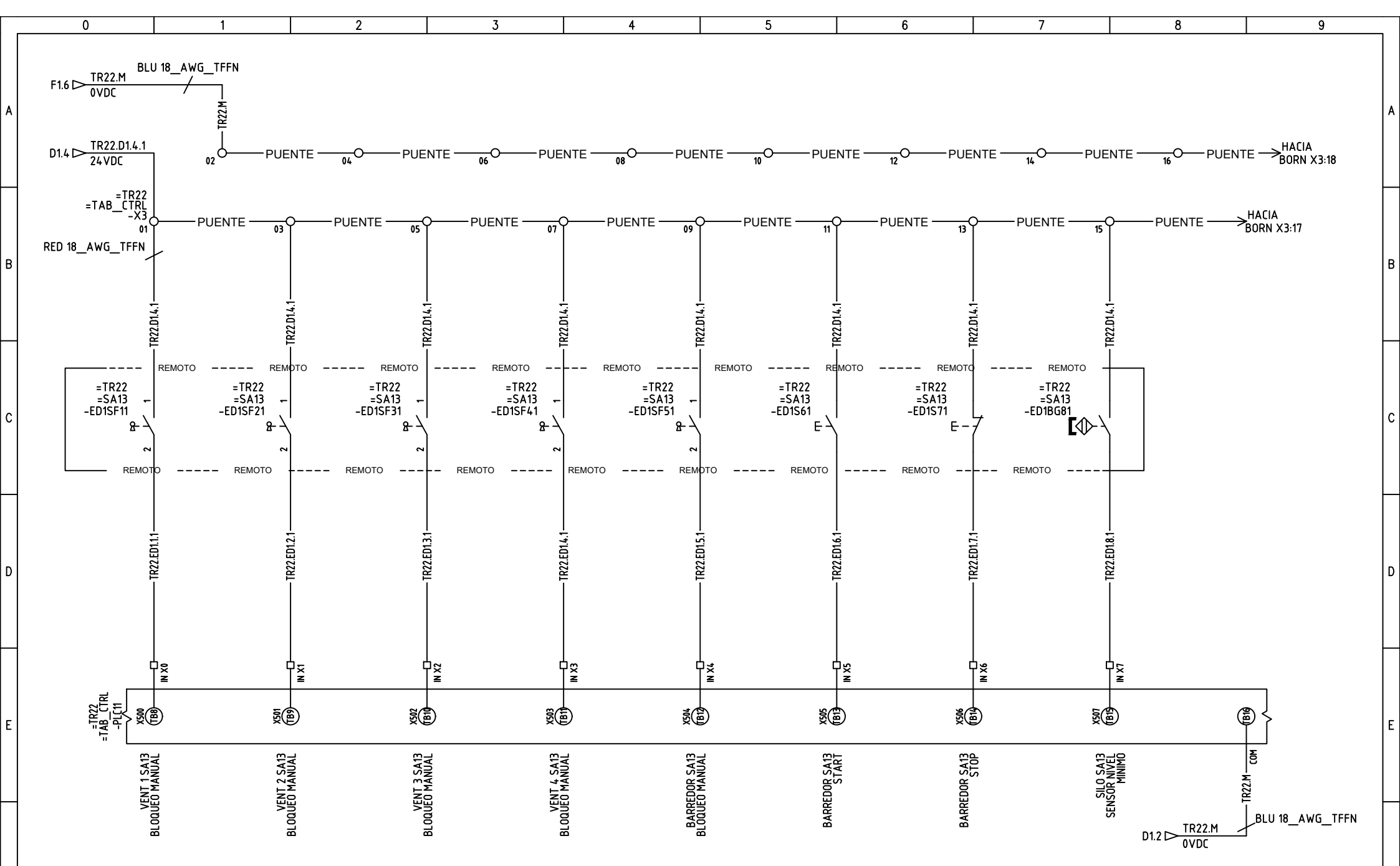

4				FECHA:	17/Mar/2020
3				DISEÑO:	L.F.G.G.
2				DIBUJÓ:	L.F.G.G.
1				REVISÓ:	J.D.A.H
REV.	DESCRIPCIÓN	FECHA	NOMBRE	APROBÓ:	J.D.A.H



 TEL: (+57 4) 4 44 74 41

 Cr. 48C # 100 Sur - 72

 La Estrella - Antioquia

 www.elicogrp.com

CONTIENE:	ENTRADAS DIGITALES
	MÓDULO 1 CC-LINK I/O 16 DC SNK/SCE INPUTS
	AJ65SBTB1-16D
PROYECTO:	AUTOMATIZACIÓN SILOS
CLIENTE:	SOCIEDAD PORTUARIA SANTA MARTA

IMPRESO: 20 marzo 2020	
ED1- ENTRADAS DIGITALES	
ANTERIOR: G1	#ORDEN: 0120004
ESQUEMA: ED1	#REVISIÓN: 1
SIGUIENTE: ED2	TOTAL HOJAS: 020

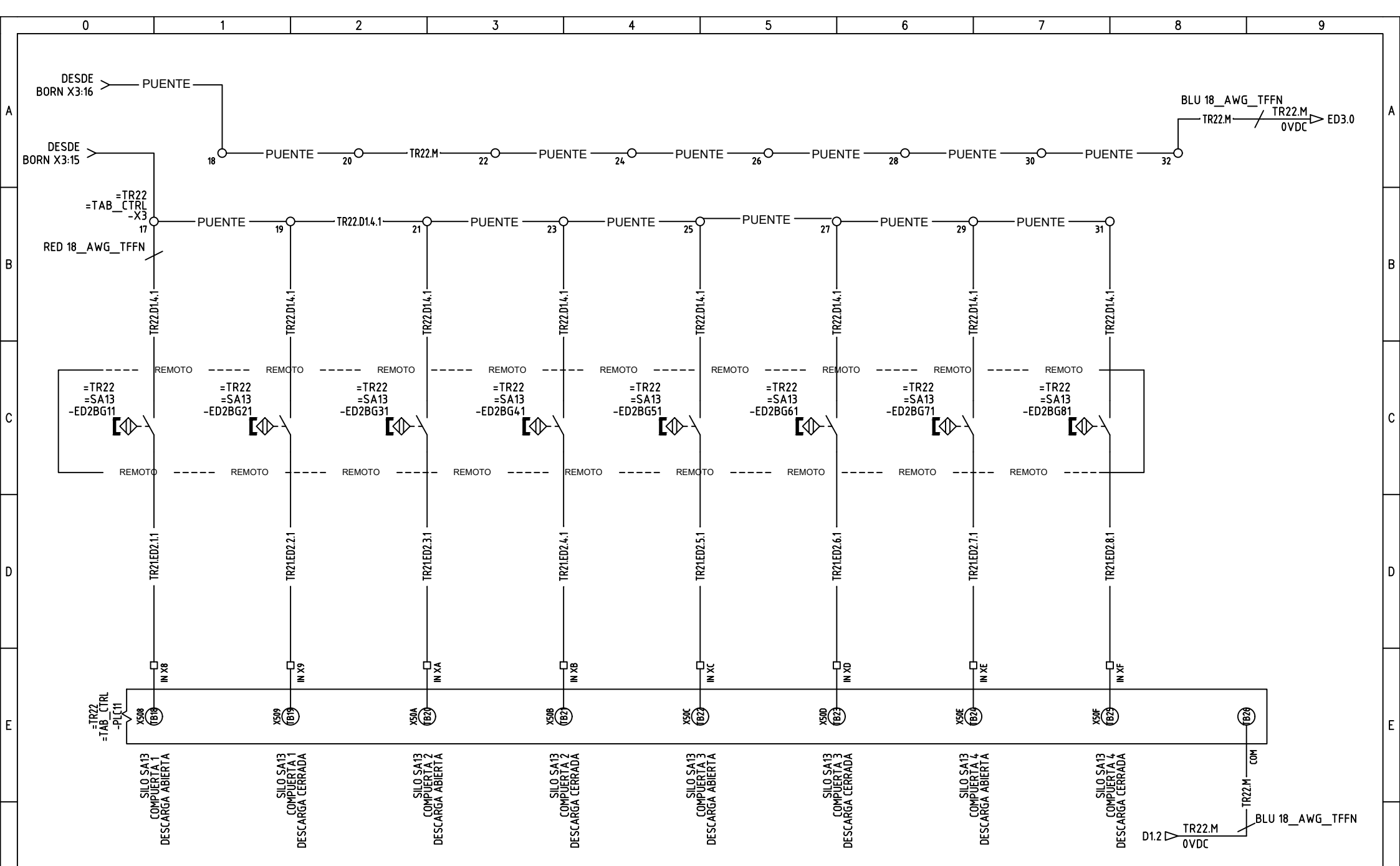

4				FECHA:	17/Mar/2020
3				DISEÑO:	L.F.G.G.
2				DIBUJÓ:	L.F.G.G.
1				REVISÓ:	J.D.A.H
REV.	DESCRIPCIÓN	FECHA	NOMBRE	APROBÓ:	J.D.A.H



 TEL: (+57 4) 4 44 74 41

 Cr. 48C # 100 Sur - 72

 La Estrella - Antioquia

 www.elicogrp.com

CONTIENE:	ENTRADAS DIGITALES
	MÓDULO 1 CC-LINK I/O 16 DC SNK/SCE INPUTS
	AJ65SBTB1-16D
PROYECTO:	AUTOMATIZACIÓN SILOS
CLIENTE:	SOCIEDAD PORTUARIA SANTA MARTA

IMPRESO: 20 marzo 2020	
ED2- ENTRADAS DIGITALES	
ANTERIOR: ED1	#ORDEN: 0120004
ESQUEMA: ED2	#REVISIÓN: 1
SIGUIENTE: ED3	TOTAL HOJAS: 020

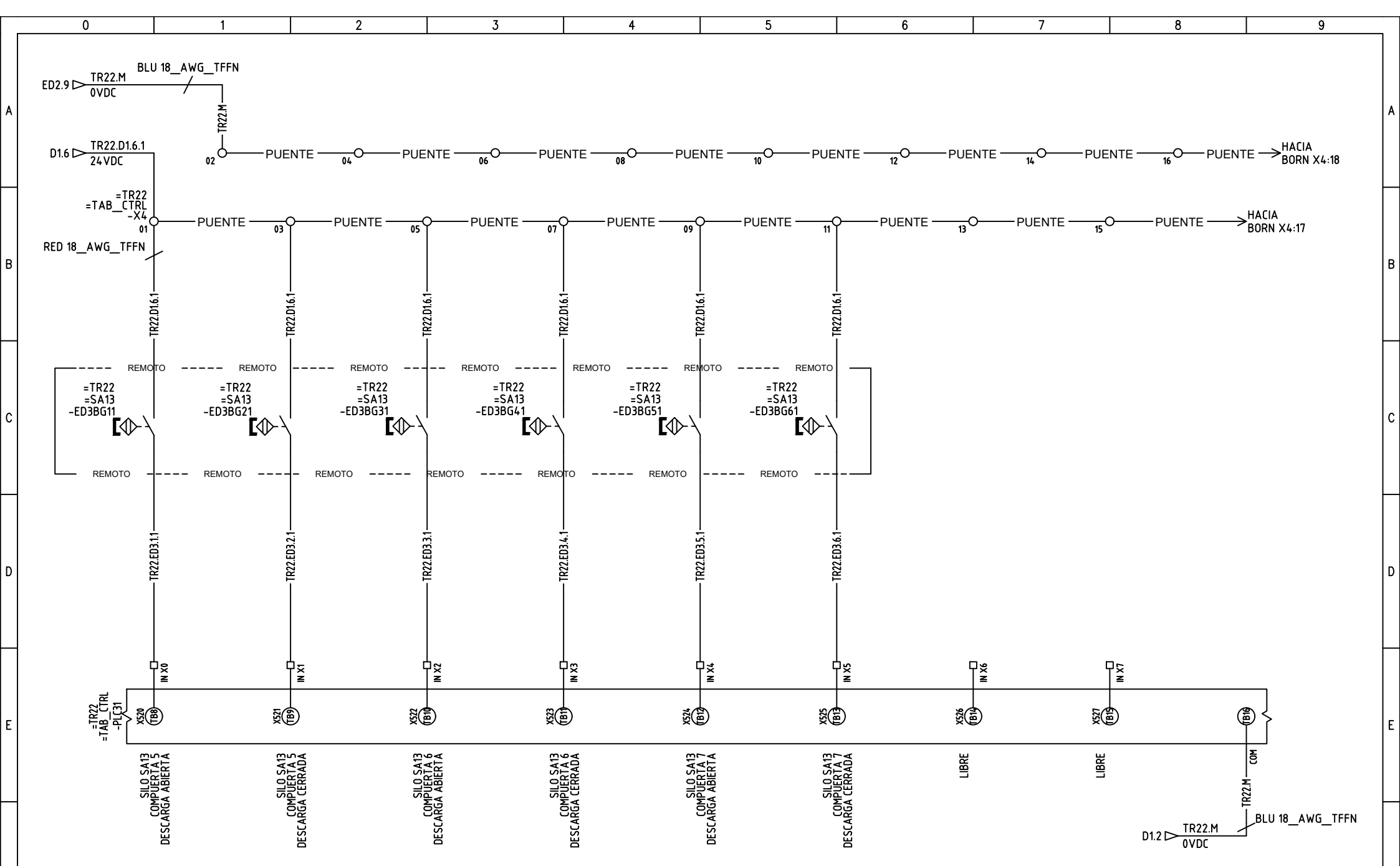

4				FECHA:	17/Mar/2020
3				DISEÑO:	L.F.G.G.
2				DIBUJÓ:	L.F.G.G.
1				REVISÓ:	J.D.A.H
REV.	DESCRIPCIÓN	FECHA	NOMBRE	APROBÓ:	J.D.A.H



 TEL: (+57 4) 4 44 74 41
 Cr. 48C # 100 Sur - 72
 La Estrella - Antioquia
 www.elicogrp.com

CONTIENE:	ENTRADAS DIGITALES MÓDULO 2 CC-LINK I/O 16 DC SNK/SCE INPUTS AJ65SBT1-16D
PROYECTO:	AUTOMATIZACIÓN SILOS
CLIENTE:	SOCIEDAD PORTUARIA SANTA MARTA

IMPRESO:	20 marzo 2020
ED3- ENTRADAS DIGITALES	
ANTERIOR:	ED2
ESQUEMA:	ED3
SIGUIENTE:	ED4
#ORDEN:	OI20004
#REVISIÓN:	1
TOTAL HOJAS:	020

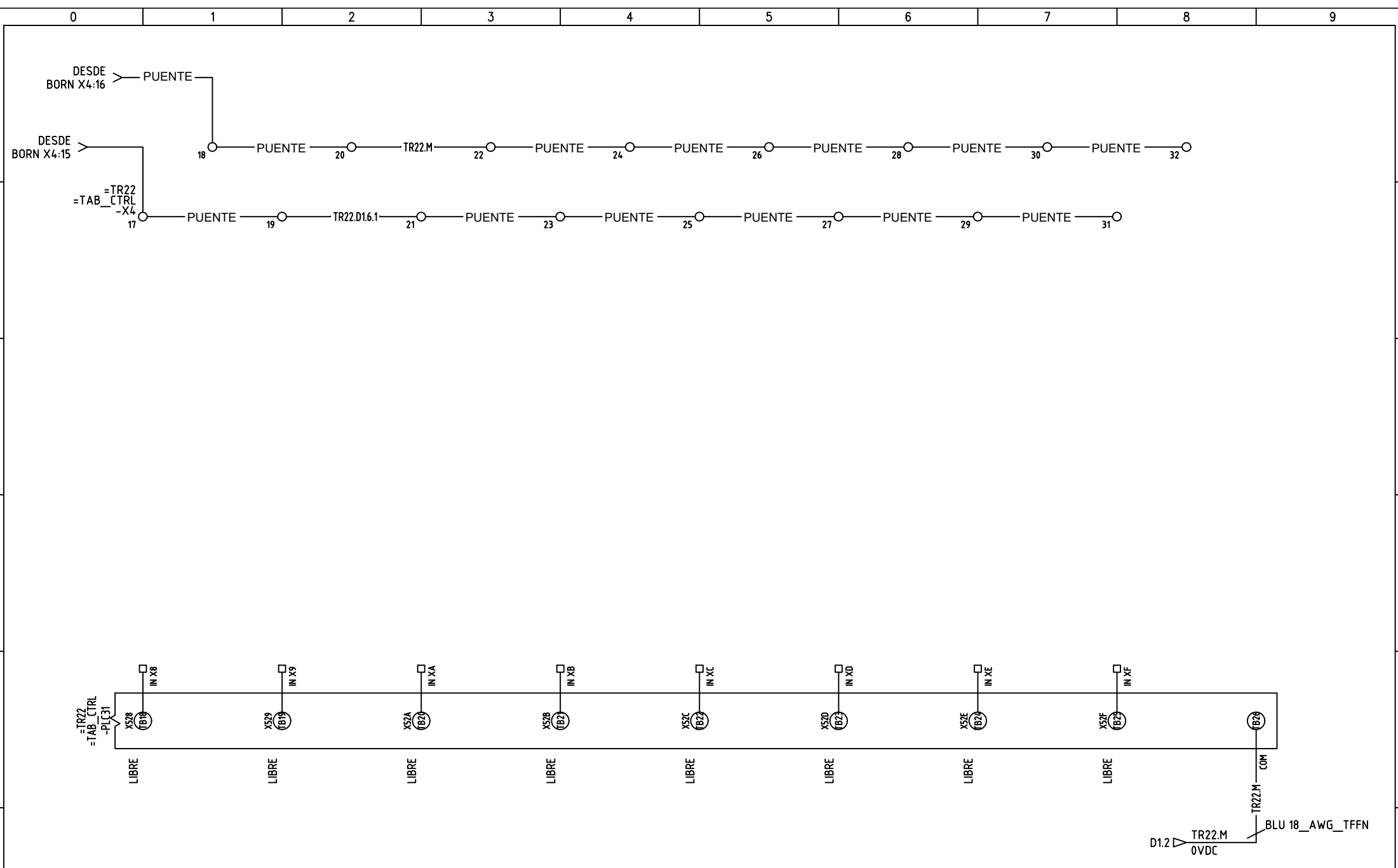

4				FECHA:	17/Mar/2020
3				DISEÑO:	L.F.G.G.
2				DIBUJÓ:	L.F.G.G.
1				REVISÓ:	J.D.A.H
REV.	DESCRIPCIÓN	FECHA	NOMBRE	APROBÓ:	J.D.A.H



 TEL: (+57 4) 4 44 74 41
 Cr. 48C # 100 Sur - 72
 La Estrella - Antioquia
 www.elicogrp.com

CONTIENE:	ENTRADAS DIGITALES MÓDULO 2 CC-LINK I/O 16 DC SNK/SCE INPUTS AJ65SBTB1-16D
PROYECTO:	AUTOMATIZACIÓN SILOS
CLIENTE:	SOCIEDAD PORTUARIA SANTA MARTA

IMPRESO:	20 marzo 2020
ED4- ENTRADAS DIGITALES	
ANTERIOR:	ED3
ESQUEMA:	ED4
SIGUIENTE:	SD1
#ORDEN:	OI20004
#REVISIÓN:	1
TOTAL HOJAS:	020

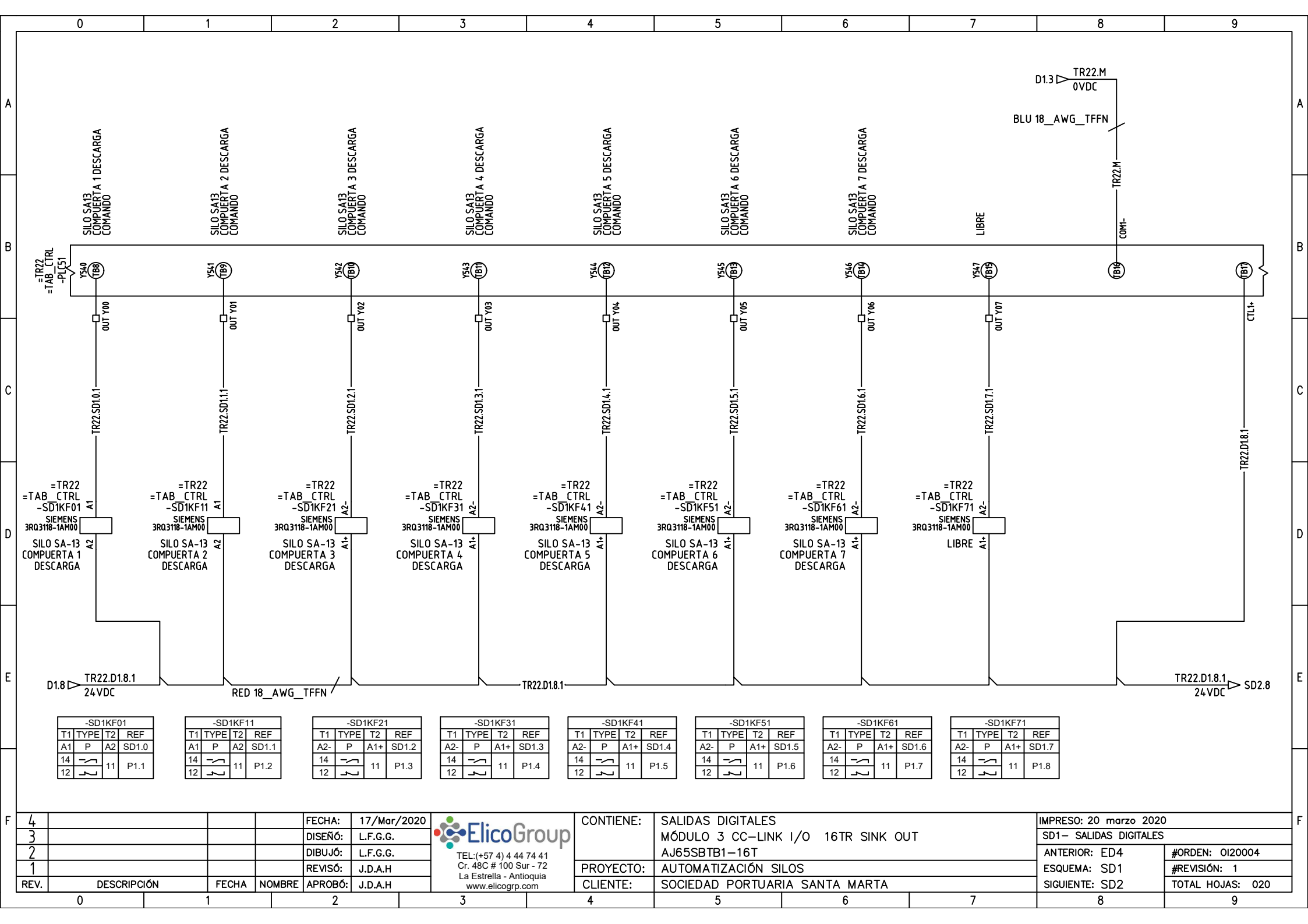

-SD1KF01			
T1	TYPE	T2	REF
A1	P	A2	SD1.0
14		11	P1.1
12			

-SD1KF11			
T1	TYPE	T2	REF
A1	P	A2	SD1.1
14		11	P1.2
12			

-SD1KF21			
T1	TYPE	T2	REF
A2-	P	A1+	SD1.2
14		11	P1.3
12			

-SD1KF31			
T1	TYPE	T2	REF
A2-	P	A1+	SD1.3
14		11	P1.4
12			

-SD1KF41			
T1	TYPE	T2	REF
A2-	P	A1+	SD1.4
14		11	P1.5
12			

-SD1KF51			
T1	TYPE	T2	REF
A2-	P	A1+	SD1.5
14		11	P1.6
12			

-SD1KF61			
T1	TYPE	T2	REF
A2-	P	A1+	SD1.6
14		11	P1.7
12			

-SD1KF71			
T1	TYPE	T2	REF
A2-	P	A1+	SD1.7
14		11	P1.8
12			

4				FECHA:	17/Mar/2020
3				DISEÑO:	L.F.G.G.
2				DIBUJÓ:	L.F.G.G.
1				REVISÓ:	J.D.A.H
REV.	DESCRIPCIÓN	FECHA	NOMBRE	APROBÓ:	J.D.A.H

TEL: (+57 4) 4 44 74 41
Cr. 48C # 100 Sur - 72
La Estrella - Antioquia
www.elicogrp.com

CONTIENE:	SALIDAS DIGITALES MÓDULO 3 CC-LINK I/O 16TR SINK OUT AJ65SBTB1-16T
PROYECTO:	AUTOMATIZACIÓN SILOS
CLIENTE:	SOCIEDAD PORTUARIA SANTA MARTA

IMPRESO:	20 marzo 2020
SD1- SALIDAS DIGITALES	
ANTERIOR:	ED4 #ORDEN: 0120004
ESQUEMA:	SD1 #REVISIÓN: 1
SIGUIENTE:	SD2 TOTAL HOJAS: 020

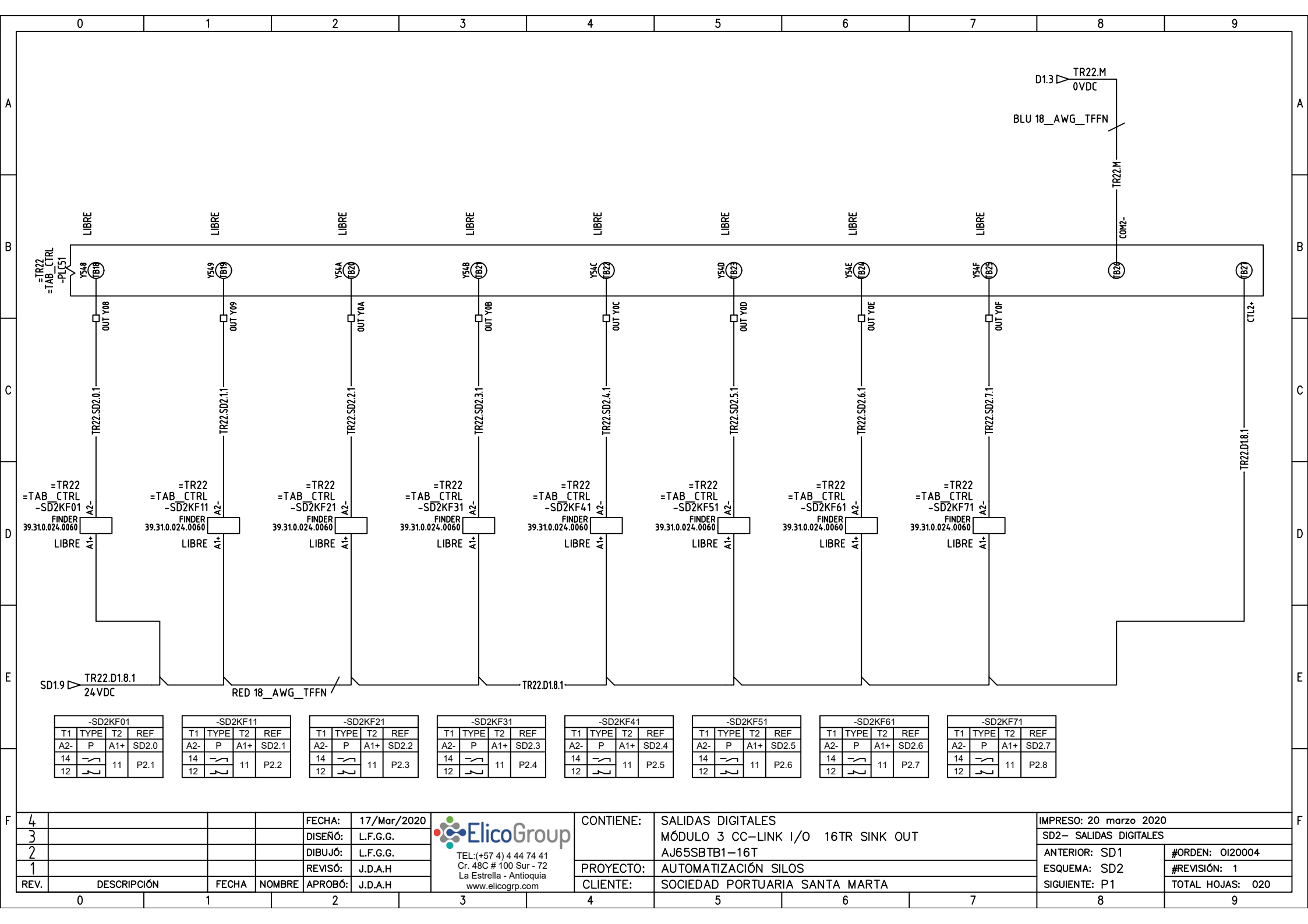

T1	TYPE	T2	REF
A2-	P	A1+	SD2.0
14		11	P2.1
12			

T1	TYPE	T2	REF
A2-	P	A1+	SD2.1
14		11	P2.2
12			

T1	TYPE	T2	REF
A2-	P	A1+	SD2.2
14		11	P2.3
12			

T1	TYPE	T2	REF
A2-	P	A1+	SD2.3
14		11	P2.4
12			

T1	TYPE	T2	REF
A2-	P	A1+	SD2.4
14		11	P2.5
12			

T1	TYPE	T2	REF
A2-	P	A1+	SD2.5
14		11	P2.6
12			

T1	TYPE	T2	REF
A2-	P	A1+	SD2.6
14		11	P2.7
12			

T1	TYPE	T2	REF
A2-	P	A1+	SD2.7
14		11	P2.8
12			

4				FECHA:	17/Mar/2020
3				DISEÑO:	L.F.G.G.
2				DIBUJÓ:	L.F.G.G.
1				REVISÓ:	J.D.A.H
REV.	DESCRIPCIÓN	FECHA	NOMBRE	APROBÓ:	J.D.A.H

ElicoGroup
 TEL: (+57 4) 4 44 74 41
 Cr. 48C # 100 Sur - 72
 La Estrella - Antioquia
 www.elicogrp.com

CONTIENE:	SALIDAS DIGITALES MÓDULO 3 CC-LINK I/O 16TR SINK OUT AJ65SBTB1-16T
PROYECTO:	AUTOMATIZACIÓN SILOS
CLIENTE:	SOCIEDAD PORTUARIA SANTA MARTA

IMPRESO:	20 marzo 2020
SD2- SALIDAS DIGITALES	
ANTERIOR:	SD1
ESQUEMA:	SD2
SIGUIENTE:	P1
#ORDEN:	OI20004
#REVISIÓN:	1
TOTAL HOJAS:	020

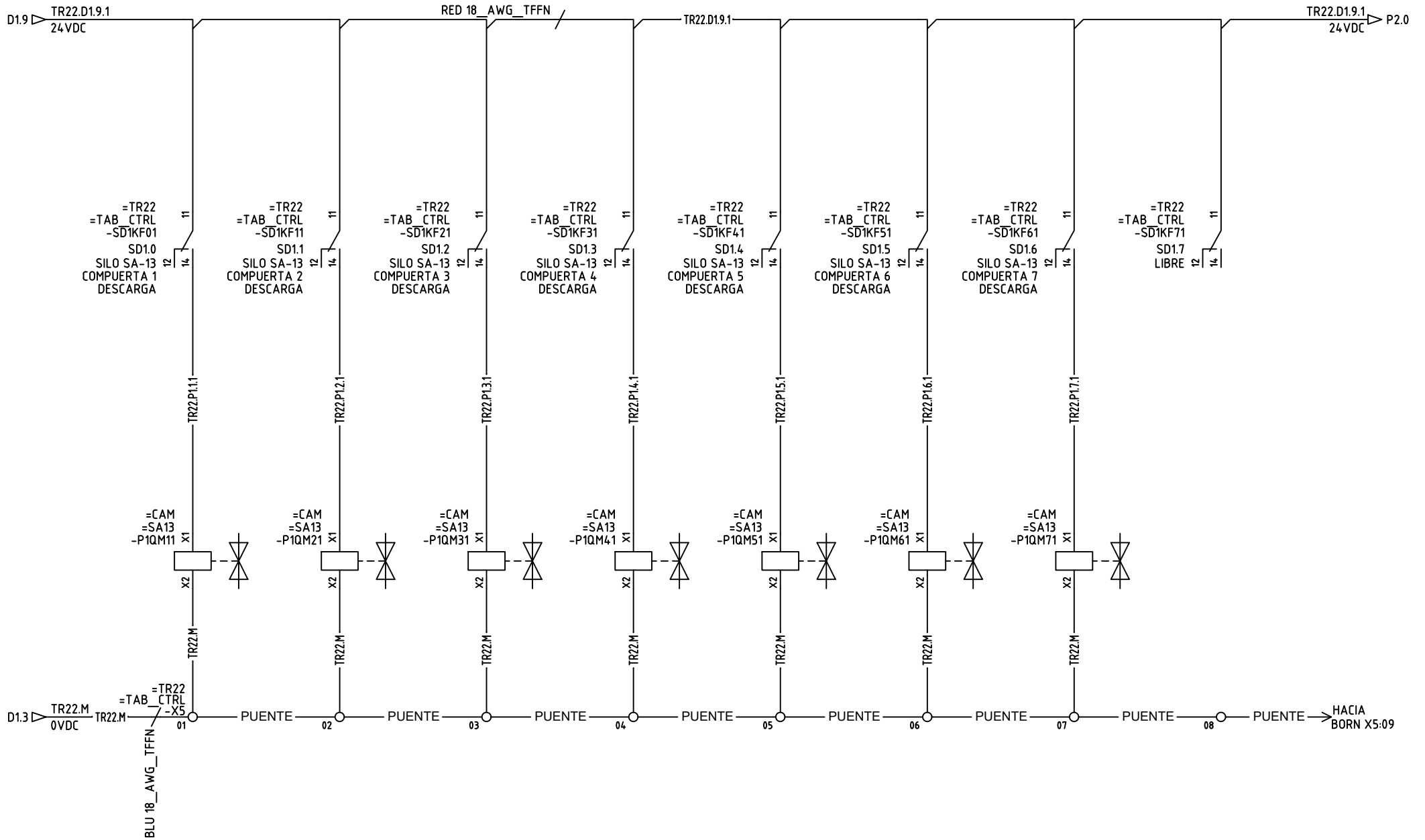

4				FECHA:	17/Mar/2020
3				DISEÑO:	L.F.G.G.
2				DIBUJÓ:	L.F.G.G.
1				REVISÓ:	J.D.A.H
REV.	DESCRIPCIÓN	FECHA	NOMBRE	APROBÓ:	J.D.A.H

ElicoGroup
 TEL: (+57 4) 4 44 74 41
 Cr. 48C # 100 Sur - 72
 La Estrella - Antioquia
 www.elicogrp.com

CONTIENE:	SALIDAS RELEVADAS 24VDC MÓDULO 3 PLC15
PROYECTO:	AUTOMATIZACIÓN SILOS
CLIENTE:	SOCIEDAD PORTUARIA SANTA MARTA

IMPRESO:	20 marzo 2020
P1- SALIDAS RELEVADAS	
ANTERIOR:	SD2 #ORDEN: 0120004
ESQUEMA:	P1 #REVISIÓN: 1
SIGUIENTE:	P2 TOTAL HOJAS: 20

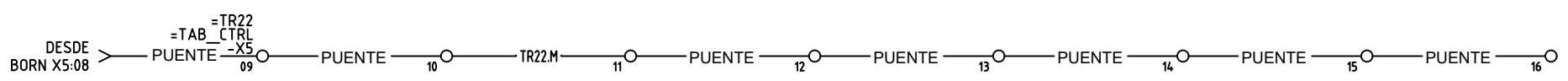
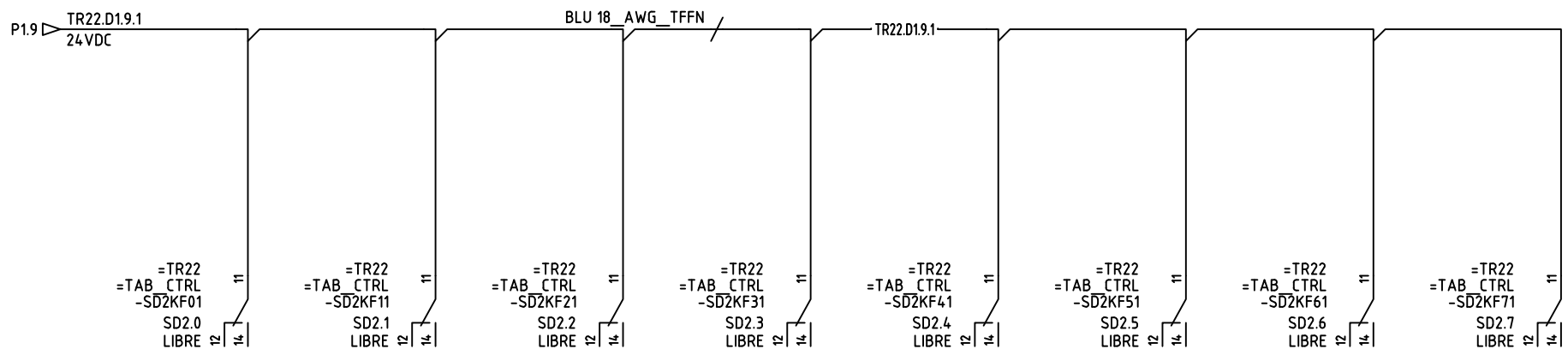

4				FECHA:	17/Mar/2020
3				DISEÑO:	L.F.G.G.
2				DIBUJÓ:	L.F.G.G.
1				REVISÓ:	J.D.A.H
REV.	DESCRIPCIÓN	FECHA	NOMBRE	APROBÓ:	J.D.A.H

TEL: (+57 4) 4 44 74 41
Cr. 48C # 100 Sur - 72
La Estrella - Antioquia
www.elicogrp.com

CONTIENE:	SALIDAS RELEVADAS 24VDC MÓDULO 3 PLC15
PROYECTO:	AUTOMATIZACIÓN SILOS
CLIENTE:	SOCIEDAD PORTUARIA SANTA MARTA

IMPRESO: 20 marzo 2020	
P2- SALIDAS RELEVADAS	
ANTERIOR: P1	#ORDEN: 0120004
ESQUEMA: P2	#REVISIÓN: 1
SIGUIENTE: L1	TOTAL HOJAS: 20

ETIQUETAS	CTDAD	SUB	CATÁLOGO	FABRI	DESCRIPCIÓN
-D1QA31 -D1QA41 -D1QA51 -D1QA61 -D1QA71 -D1QA81 -D1QA91	7		5SL4101-7	SIEMENS	MINIATURE CIRCUIT BREAKER 5SL, 10KA 1-POLE CIRCUIT BREAKER 1AMPS THERMAL AND FIXED MAGNETIC TRIP 230VAC
-D1QA11	1		5SL4104-7	SIEMENS	Automático magnetotérmico MINI BREAKER CIRCUIT, 1 POLE, C, 10KA 4A 230/400V
-SD2KF01 -SD2KF11 -SD2KF21 -SD2KF31 -SD2KF41 -SD2KF51 -SD2KF61 -SD2KF71	8		39.31.0.024.0060	FINDER	
-SD1KF01 -SD1KF11 -SD1KF21 -SD1KF31 -SD1KF41 -SD1KF51 -SD1KF61 -SD1KF71	8		3RQ3118-1AM00	SIEMENS	Relés de interfaz de entrada con bornes relé 1 conmutado borne de tornillo AC/DC 24 VDC / Corriente térmica 6A
-PLC11 -PLC31	2		AJ65BTB1-16D	MITSUBISHI	MELSEC A DISCRETE INPUT MODULE MELSEC A DISCRETE INPUT 24VDC 16 POINTS, SINK/SOURCE
-PLC51	1		AJ65BTB1-16T	MITSUBISHI	MELSEC A DISCRETE OUTPUT MODULE MELSEC A DISCRETE OUTPUT 12/24VDC 16 POINTS
-ED3BG71 -ED3BG81	2		BSE1V10C	4B	
-D1SU11	1		3824-DIN	LEVINTON	
-X5	1		3030213	PHOENIX CONTACT	PLUG-IN BRIDGE JUMP 50.6 mm, number of positions: 10, color: red FBS10-5
-X1 -X2	9		3209510	PHOENIX CONTACT	BORNE DE PASO Conexión push-in 24A 0,14 mm² - 4 mm², AWG: 26 - 12 anchura: 5,2 mm, altura: 35,3 mm, color: gris, clase de montaje: NS 35/7,5, NS 35/15
-X1	1		3209536	PHOENIX CONTACT	Borne de tierra para carril Conexión push-in PA 6KV número de conexiones: 2, sección: 0,14 mm² - 4 mm², AWG: 26 - 12 ancho: 5,2 mm, alto: 35,3 mm, amarillo-verde
-X3 -X4	16		3210567	PHOENIX CONTACT	Borne de doble piso Conexión push-in sección: 0,14 mm² - 4 mm², AWG: 26 - 12 anchura: 5,2 mm, color: gris clase de montaje: NS 35/7,5, NS 35/15

4			FECHA:	17/Mar/2020
3			DISEÑO:	L.F.G.G.
2			DIBUJÓ:	L.F.G.G.
1			REVISÓ:	J.D.A.H
REV.	DESCRIPCIÓN	FECHA	NOMBRE	APROBÓ:
			J.D.A.H	



TEL: (+57 4) 4 44 74 41
Cr. 48C # 100 Sur - 72
La Estrella - Antioquia
www.elicogrp.com

CONTIENE:	LISTA DE MATERIALES
PROYECTO:	AUTOMATIZACIÓN SILOS
CLIENTE:	SOCIEDAD PORTUARIA SANTA MARTA

IMPRESO: 20 marzo 2020	
LISTA DE MATERIALES_L1	
ANTERIOR: P2	#ORDEN: 0120004
ESQUEMA: L1	#REVISIÓN: 1
SIGUIENTE: L2	TOTAL HOJAS: 20

ETIQUETAS	CTDAD	SUB	CATÁLOGO	FABRI	DESCRIPCIÓN
-X3 -X4	16		3210567	PHOENIX CONTACT	Borne de doble piso Conexión push-in sección: 0,14 mm ² - 4 mm ² , AWG: 26 - 12 anchura: 5,2 mm, color: gris clase de montaje: NS 35/7,5, NS 35/15
-X5	8		3210567	PHOENIX CONTACT	Borne de doble piso Conexión push-in sección: 0,14 mm ² - 4 mm ² , AWG: 26 - 12 anchura: 5,2 mm, color: gris clase de montaje: NS 35/7,5, NS 35/15

4				FECHA:	17/Mar/2020
3				DISEÑO:	L.F.G.G.
2				DIBUJÓ:	L.F.G.G.
1				REVISÓ:	J.D.A.H
REV.	DESCRIPCIÓN	FECHA	NOMBRE	APROBÓ:	J.D.A.H



TEL:(+57 4) 4 44 74 41
Cr. 48C # 100 Sur - 72
La Estrella - Antioquia
www.elicogrp.com

CONTIENE:		IMPRESO: 20 marzo 2020
		LISTA DE MATERIALES_L2
PROYECTO:	AUTOMATIZACIÓN SILOS	ANTERIOR: L1 #ORDEN: 0I20004
CLIENTE:	SOCIEDAD PORTUARIA SANTA MARTA	ESQUEMA: L2 #REVISIÓN: 1
		SIGUIENTE: K1 TOTAL HOJAS: 20

GRUPO DE BORN X1: ALIMENTACIÓN PRINCIPAL 24VDC													
Dispositivo1	Polo1	Cable1	Tipo1	T1	Número	T2	Fabricante	Catálogo	Tipo2	Cable2	Polo2	Dispositivo2	Puente
					1		PHOENIX CONTACT	3022218					
-D1SU11	PE	TR21.PE	GRN_18_AWG_T_FFN		01		PHOENIX CONTACT	3209536	GRN_18_AWG_T_FFN	TR21.PE			○ ○ ○
-PLC11	TB6	TR21.PE	GRN_18_AWG_T_FFN		01								○ ○ ○
-D1QA11	1	TR21.D1.0.1	RED_18_AWG_TF_FFN		02		PHOENIX CONTACT	3209510	RED_18_AWG_TF_FFN	TR21.D1.0.1			○ ○ ○
-D1SU11	0VDC	TR21.M	BLU_18_AWG_TF_FFN		03		PHOENIX CONTACT	3209510	BLU_18_AWG_TF_FFN	TR21.M	01	-X2	● ○ ○ ○ ○ ○
					1		PHOENIX CONTACT	3030417					
					1		PHOENIX CONTACT	3022218					

4				FECHA:	17/Mar/2020
3				DISEÑO:	L.F.G.G.
2				DIBUJÓ:	L.F.G.G.
1				REVISÓ:	J.D.A.H
REV.	DESCRIPCIÓN	FECHA	NOMBRE	APROBÓ:	J.D.A.H



TEL: (+57 4) 4 44 74 41
Cr. 48C # 100 Sur - 72
La Estrella - Antioquia
www.elicogrp.com

CONTIENE:	LISTADO DE BORNERAS
PROYECTO:	AUTOMATIZACIÓN SILOS
CLIENTE:	SOCIEDAD PORTUARIA SANTA MARTA

IMPRESO: 20 marzo 2020	
LISTADO DE BORNERAS_K1	
ANTERIOR: L2	#ORDEN: 0120004
ESQUEMA: K1	#REVISIÓN: 1
SIGUIENTE: K2	TOTAL HOJAS: 20

GRUPO DE BORN X2: COMÚN 0VDC													
Dispositivo1	Polo1	Cable1	Tipo1	T1	Número	T2	Fabricante	Catálogo	Tipo2	Cable2	Polo2	Dispositivo2	Puente
					1		PHOENIX CONTACT	3022218					
-X1	03	TR21.M	BLU_18_AWG_TF_FN		01		PHOENIX CONTACT	3209510	BLU_18_AWG_TF_FN	TR21.M	TB16	-PLC11	⊙ ⊙ ⊙
-PLC11	TB26	TR21.M	BLU_18_AWG_TF_FN		02		PHOENIX CONTACT	3209510					⊙ ⊙ ⊙
-PLC31	TB16	TR21.M	BLU_18_AWG_TF_FN		03		PHOENIX CONTACT	3209510					⊙ ⊙ ⊙
-PLC31	TB26	TR21.M	BLU_18_AWG_TF_FN		04		PHOENIX CONTACT	3209510					⊙ ⊙ ⊙
-PLC51	TB16	TR21.M	BLU_18_AWG_TF_FN		05		PHOENIX CONTACT	3209510					⊙ ⊙ ⊙
-?-PLC51	TB26	TR21.M	BLU_18_AWG_TF_FN		06		PHOENIX CONTACT	3209510					⊙ ⊙ ⊙
-X5	01	TR21.M	BLU_18_AWG_TF_FN		07		PHOENIX CONTACT	3209510					⊙ ⊙ ⊙
					1		PHOENIX CONTACT	3030417					
					1		PHOENIX CONTACT	3022218					

4				FECHA:	17/Mar/2020
3				DISEÑO:	L.F.G.G.
2				DIBUJÓ:	L.F.G.G.
1				REVISÓ:	J.D.A.H
REV.	DESCRIPCIÓN	FECHA	NOMBRE	APROBÓ:	J.D.A.H



TEL: (+57 4) 4 44 74 41
Cr. 48C # 100 Sur - 72
La Estrella - Antioquia
www.elicogrp.com

CONTIENE:	LISTADO DE BORNERAS
PROYECTO:	AUTOMATIZACIÓN SILOS
CLIENTE:	SOCIEDAD PORTUARIA SANTA MARTA

IMPRESO: 20 marzo 2020	
LISTADO DE BORNERAS_K2	
ANTERIOR: K1	#ORDEN: 0120004
ESQUEMA: K2	#REVISIÓN: 1
SIGUIENTE: K3	TOTAL HOJAS: 20

GRUPO DE BORN X3: COMUNES ENTRADAS DIGITALES

Dispositivo1	Polo1	Cable1	Tipo1	T1	Número	T2	Fabricante	Catálogo	Tipo2	Cable2	Polo2	Dispositivo2	Puente
-D1QA41	2	TR21.D1.4.1	RED_1 8_AWG G_TFF N		01		PHOENIX CONTACT	3210567	RED_1 8_AWG G_TFF N	TR21.D1.4.1	1	-ED1SF11	● ○ ○
-PLC51	TB7	TR21.M	BLU_1 8_AWG G_TFF N		02								○ ● ○
-ED1SF21	1	TR21.D1.4.1	RED_1 8_AWG G_TFF N		03		PHOENIX CONTACT	3210567					● ○ ○
					04								○ ● ○
-ED1SF31	1	TR21.D1.4.1	RED_1 8_AWG G_TFF N		05		PHOENIX CONTACT	3210567					● ○ ○
					06								○ ● ○
-ED1SF41	1	TR21.D1.4.1	RED_1 8_AWG G_TFF N		07		PHOENIX CONTACT	3210567					● ○ ○
					08								○ ● ○
-ED1SF51	1	TR21.D1.4.1	RED_1 8_AWG G_TFF N		09		PHOENIX CONTACT	3210567					● ○ ○
					10								○ ● ○
-ED1S61		TR21.D1.4.1	RED_1 8_AWG G_TFF N		11		PHOENIX CONTACT	3210567					● ○ ○
					12								○ ● ○
-ED1S71		TR21.D1.4.1	RED_1 8_AWG G_TFF N		13		PHOENIX CONTACT	3210567					● ○ ○
					14								○ ● ○
-ED1BG81		TR21.D1.4.1	RED_1 8_AWG G_TFF N		15		PHOENIX CONTACT	3210567					● ○ ○
					16								○ ● ○
-ED2BG11		TR21.D1.4.1	RED_1 8_AWG G_TFF N		17		PHOENIX CONTACT	3210567					● ○ ○
					18								○ ● ○
-ED2BG21		TR21.D1.4.1	RED_1 8_AWG G_TFF N		19		PHOENIX CONTACT	3210567	RED_1 8_AWG G_TFF N	TR21.D1.4.1	21	-X3	● ○ ○
					20								○ ● ○
-X3	22	TR21.M	BLU_1 8_AWG G_TFF N										● ○ ○

GRUPO DE BORN X3: COMUNES ENTRADAS DIGITALES

Dispositivo1	Polo1	Cable1	Tipo1	T1	Número	T2	Fabricante	Catálogo	Tipo2	Cable2	Polo2	Dispositivo2	Puente
-X3	19	TR21.D1.4.1	RED_1 8_AWG TFFN		21		PHOENIX CONTACT	3210567	RED_1 8_AWG TFFN	TR21.D1.4.1		-ED2BG31	● ○ ○
-X3	20	TR21.M	BLU_1 8_AWG TFFN		22								○ ● ○
-ED2BG41		TR21.D1.4.1	RED_1 8_AWG TFFN		23		PHOENIX CONTACT	3210567					● ○ ○
					24								○ ● ○
-ED2BG51		TR21.D1.4.1	RED_1 8_AWG TFFN		25		PHOENIX CONTACT	3210567					● ○ ○
					26								○ ● ○
-ED2BG61		TR21.D1.4.1	RED_1 8_AWG TFFN		27		PHOENIX CONTACT	3210567					● ○ ○
					28								○ ● ○
-ED2BG71		TR21.D1.4.1	RED_1 8_AWG TFFN		29		PHOENIX CONTACT	3210567					● ○ ○
					30								○ ● ○
-ED2BG81		TR21.D1.4.1	RED_1 8_AWG TFFN		31		PHOENIX CONTACT	3210567					● ○ ○
					32								○ ● ○
-X4	02	TR21.M	BLU_1 8_AWG TFFN										● ○ ○

4				FECHA:	17/Mar/2020
3				DISEÑO:	L.F.G.G.
2				DIBUJÓ:	L.F.G.G.
1				REVISÓ:	J.D.A.H
REV.	DESCRIPCIÓN	FECHA	NOMBRE	APROBÓ:	J.D.A.H



CONTIENE:	LISTADO DE BORNERAS	IMPRESO: 20 marzo 2020
PROYECTO:	AUTOMATIZACIÓN SILOS	LISTADO DE BORNERAS_K3
CLIENTE:	SOCIEDAD PORTUARIA SANTA MARTA	ANTERIOR: K2 #ORDEN: 0120004
		ESQUEMA: K3 #REVISIÓN: 1
		SIGUIENTE: K4 TOTAL HOJAS: 20

GRUPO DE BORN X4: COMUNES ENTRADAS DIGITALES													
Dispositivo1	Polo1	Cable1	Tipo1	T1	Número	T2	Fabricante	Catálogo	Tipo2	Cable2	Polo2	Dispositivo2	Puente
					1		PHOENIX CONTACT	3022218					
-D1QA61	2	TR21.D1.6.1	RED_1 8_AWG _TFFN		01		PHOENIX CONTACT	3210567	RED_1 8_AWG _TFFN	TR21.D1.6.1		-ED3BG11	● ○ ○
-X3	32	TR21.M	BLU_18 _AWG _TFFN		02								● ○ ○
-ED3BG21		TR21.D1.6.1	RED_1 8_AWG _TFFN		03		PHOENIX CONTACT	3210567					● ○ ○
					04								● ○ ○
-ED3BG31		TR21.D1.6.1	RED_1 8_AWG _TFFN		05		PHOENIX CONTACT	3210567					● ○ ○
					06								● ○ ○
-ED3BG41		TR21.D1.6.1	RED_1 8_AWG _TFFN		07		PHOENIX CONTACT	3210567					● ○ ○
					08								● ○ ○
-ED3BG51		TR21.D1.6.1	RED_1 8_AWG _TFFN		09		PHOENIX CONTACT	3210567					● ○ ○
					10								● ○ ○
-ED3BG61		TR21.D1.6.1	RED_1 8_AWG _TFFN		11		PHOENIX CONTACT	3210567					● ○ ○
					12								● ○ ○
-ED3BG71	BN	TR21.D1.6.1	BRN_1 8_AWG _THHN		13		PHOENIX CONTACT	3210567					● ○ ○
-ED3BG71	BU	TR21.M	BLU_18 _AWG _TFFN		14								● ○ ○
-ED3BG81	BN	TR21.D1.6.1	BRN_1 8_AWG _THHN		15		PHOENIX CONTACT	3210567					● ○ ○
-ED3BG81	BU	TR21.M	BLU_18 _AWG _TFFN		16								○ ○ ○
-ED4S11		TR21.D1.6.1	RED_1 8_AWG _TFFN		17		PHOENIX CONTACT	3210567					● ○ ○
					18								● ○ ○

GRUPO DE BORN X4: COMUNES ENTRADAS DIGITALES													
Dispositivo1	Polo1	Cable1	Tipo1	T1	Número	T2	Fabricante	Catálogo	Tipo2	Cable2	Polo2	Dispositivo2	Puente
-X4	21	TR21.D1.6.1	RED_1 8_AWG _TFFN		19		PHOENIX CONTACT	3210567					● ○ ○
-X4	22	TR21.M	BLU_18 _AWG _TFFN		20								● ○ ○
-X4	19	TR21.D1.6.1	RED_1 8_AWG _TFFN		21		PHOENIX CONTACT	3210567					● ○ ○
-X4	20	TR21.M	BLU_18 _AWG _TFFN		22								● ○ ○
					23		PHOENIX CONTACT	3210567					● ○ ○
					24		PHOENIX CONTACT	3210567					● ○ ○
					25		PHOENIX CONTACT	3210567					● ○ ○
					26		PHOENIX CONTACT	3210567					● ○ ○
					27		PHOENIX CONTACT	3210567					● ○ ○
					28		PHOENIX CONTACT	3210567					● ○ ○
					29		PHOENIX CONTACT	3210567					● ○ ○
					30		PHOENIX CONTACT	3210567					● ○ ○
					31		PHOENIX CONTACT	3210567					● ○ ○
					32		PHOENIX CONTACT	3210567					● ○ ○
					1		PHOENIX CONTACT	3211634					
					1		PHOENIX CONTACT	3022218					

4				FECHA:	17/Mar/2020
3				DISEÑO:	L.F.G.G.
2				DIBUJÓ:	L.F.G.G.
1				REVISÓ:	J.D.A.H
REV.	DESCRIPCIÓN	FECHA	NOMBRE	APROBÓ:	J.D.A.H



CONTIENE:	LISTADO DE BORNERAS
PROYECTO:	AUTOMATIZACIÓN SILOS
CLIENTE:	SOCIEDAD PORTUARIA SANTA MARTA

IMPRESO: 20 marzo 2020
LISTADO DE BORNERAS_K4
ANTERIOR: K3 #ORDEN: 0120004
ESQUEMA: K4 #REVISIÓN: 1
SIGUIENTE: K5 TOTAL HOJAS: 20

GRUPO DE BORN X5: SALIDAS RELEVADAS													
Dispositivo1	Polo1	Cable1	Tipo1	T1	Número	T2	Fabricante	Catálogo	Tipo2	Cable2	Polo2	Dispositivo2	Puente
					1		PHOENIX CONTACT	3022218					
-X2	07	TR21.M	BLU_18_AWG_TF_FN		01		PHOENIX CONTACT	3210567	BLU_18_AWG_TF_FN	TR21.M	X2	-P1QM11	● ○ ○
-P1QM21	X2	TR21.M	BLU_18_AWG_TF_FN		02		PHOENIX CONTACT						● ○ ○
-P1QM31	X2	TR21.M	BLU_18_AWG_TF_FN		03		PHOENIX CONTACT	3210567					● ○ ○
-P1QM41	X2	TR21.M	BLU_18_AWG_TF_FN		04		PHOENIX CONTACT						● ○ ○
-P1QM51	X2	TR21.M	BLU_18_AWG_TF_FN		05		PHOENIX CONTACT	3210567					● ○ ○
-P1QM61	X2	TR21.M	BLU_18_AWG_TF_FN		06		PHOENIX CONTACT						● ○ ○
-P1QM71	X2	TR21.M	BLU_18_AWG_TF_FN		07		PHOENIX CONTACT	3210567					● ○ ○
					08								● ○ ○
					09		PHOENIX CONTACT	3210567					● ○ ○
-X5	11	TR21.M	BLU_18_AWG_TF_FN		10		PHOENIX CONTACT						● ○ ○
-X5	10	TR21.M	BLU_18_AWG_TF_FN		11		PHOENIX CONTACT	3210567					● ○ ○
					12								● ○ ○
					13		PHOENIX CONTACT	3210567					● ○ ○
					14		PHOENIX CONTACT						● ○ ○
					15		PHOENIX CONTACT	3210567					● ○ ○
					16		PHOENIX CONTACT						● ○ ○
					1		PHOENIX CONTACT	3022218					● ○ ○
					1		PHOENIX CONTACT	3211634					● ○ ○

4				FECHA:	17/Mar/2020
3				DISEÑO:	L.F.G.G.
2				DIBUJÓ:	L.F.G.G.
1				REVISÓ:	J.D.A.H
REV.	DESCRIPCIÓN	FECHA	NOMBRE	APROBÓ:	J.D.A.H



TEL: (+57 4) 4 44 74 41
Cr. 48C # 100 Sur - 72
La Estrella - Antioquia
www.elicogrp.com

CONTIENE:	LISTADO DE BORNERAS
PROYECTO:	AUTOMATIZACIÓN SILOS
CLIENTE:	SOCIEDAD PORTUARIA SANTA MARTA

IMPRESO: 20 marzo 2020	
LISTADO DE BORNERAS_K5	
ANTERIOR: K4	#ORDEN: 0120004
ESQUEMA: K5	#REVISIÓN: 1
SIGUIENTE:	TOTAL HOJAS: 20