



TECNITANQUES
GLOBAL INFRASTRUCTURE DEVELOPMENT



**Puerto
de Santa Marta**
Sociedad Portuaria

ESTACIÓN CC - LINK SA12-T7D (TR21)

4				FECHA:	17/Mar/2020	 TEL: (+57 4) 4 44 74 41 Cr. 48C # 100 Sur - 72 La Estrella - Antioquia www.elicogrp.com	CONTIENE:	PORTADA	IMPRESO: 20 marzo 2020	
3				DISEÑO:	L.F.G.G.				IT1 - PORTADA	
2				DIBUJÓ:	L.F.G.G.				ANTERIOR:	#ORDEN: 0120004
1				REVISÓ:	J.D.A.H			PROYECTO:	ESQUEMA: IT1	#REVISIÓN: 1
REV.	DESCRIPCIÓN	FECHA	NOMBRE	APROBÓ:	J.D.A.H		CLIENTE:	SOCIEDAD PORTUARIA SANTA MARTA	SIGUIENTE: J1	TOTAL HOJAS: 020

A

B

C

D

E

F

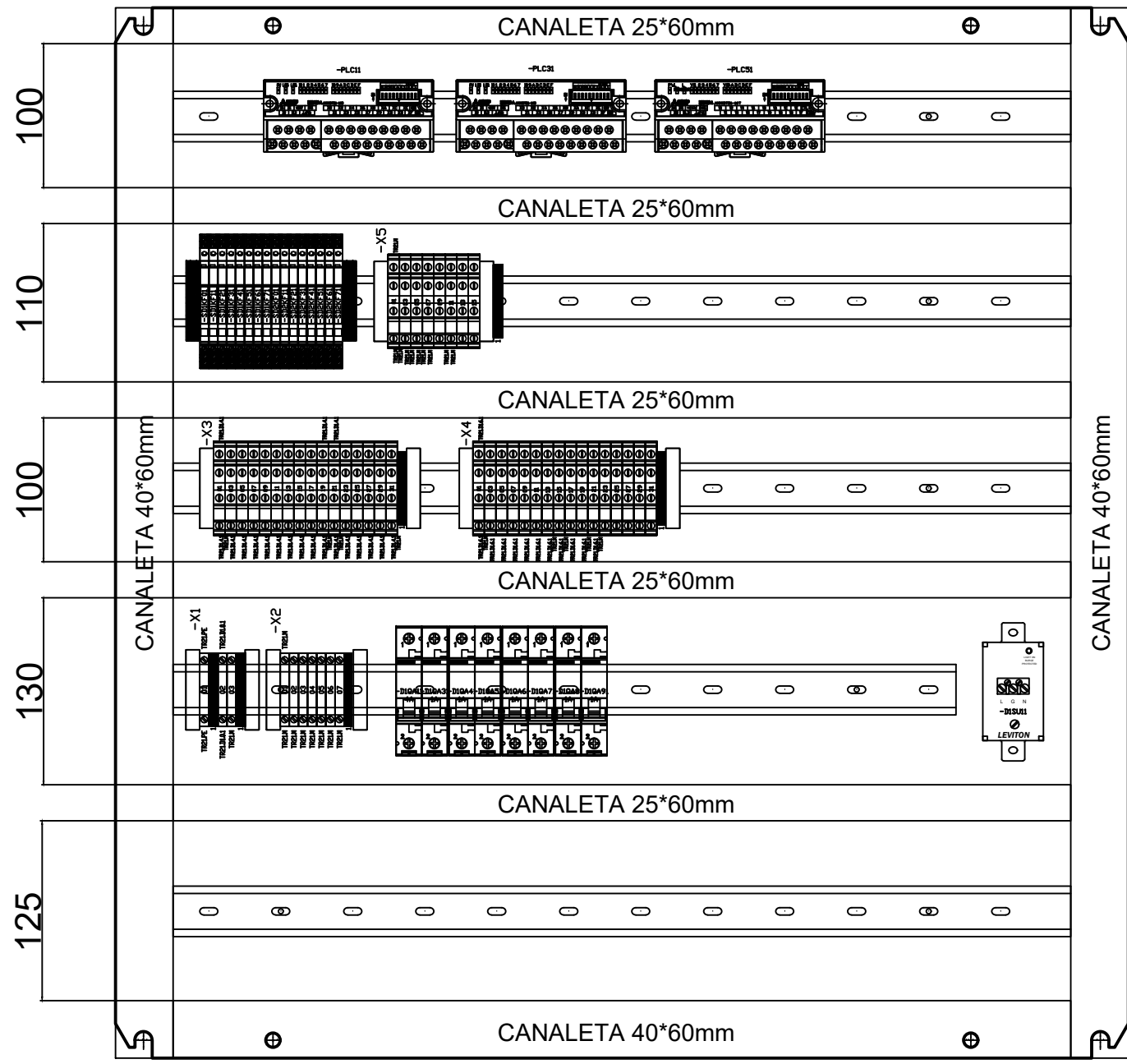

4				FECHA:	17/Mar/2020
3				DISEÑO:	L.F.G.G.
2				DIBUJÓ:	L.F.G.G.
1				REVISÓ:	J.D.A.H
REV.	DESCRIPCIÓN	FECHA	NOMBRE	APROBÓ:	J.D.A.H

ElicoGroup
 TEL: (+57 4) 4 44 74 41
 Cr. 48C # 100 Sur - 72
 La Estrella - Antioquia
 www.elicogrp.com

CONTIENE:	DISTRIBUCIÓN DOBLE FONDO
PROYECTO:	AUTOMATIZACIÓN SILOS
CLIENTE:	SOCIEDAD PORTUARIA SANTA MARTA

IMPRESO: 20 marzo 2020	
J1- DISTRIBUCIÓN DOBLE FONDO	
ANTERIOR: IT1	#ORDEN: OI20004
ESQUEMA: J1	#REVISIÓN: 1
SIGUIENTE: D1	TOTAL HOJAS: 20

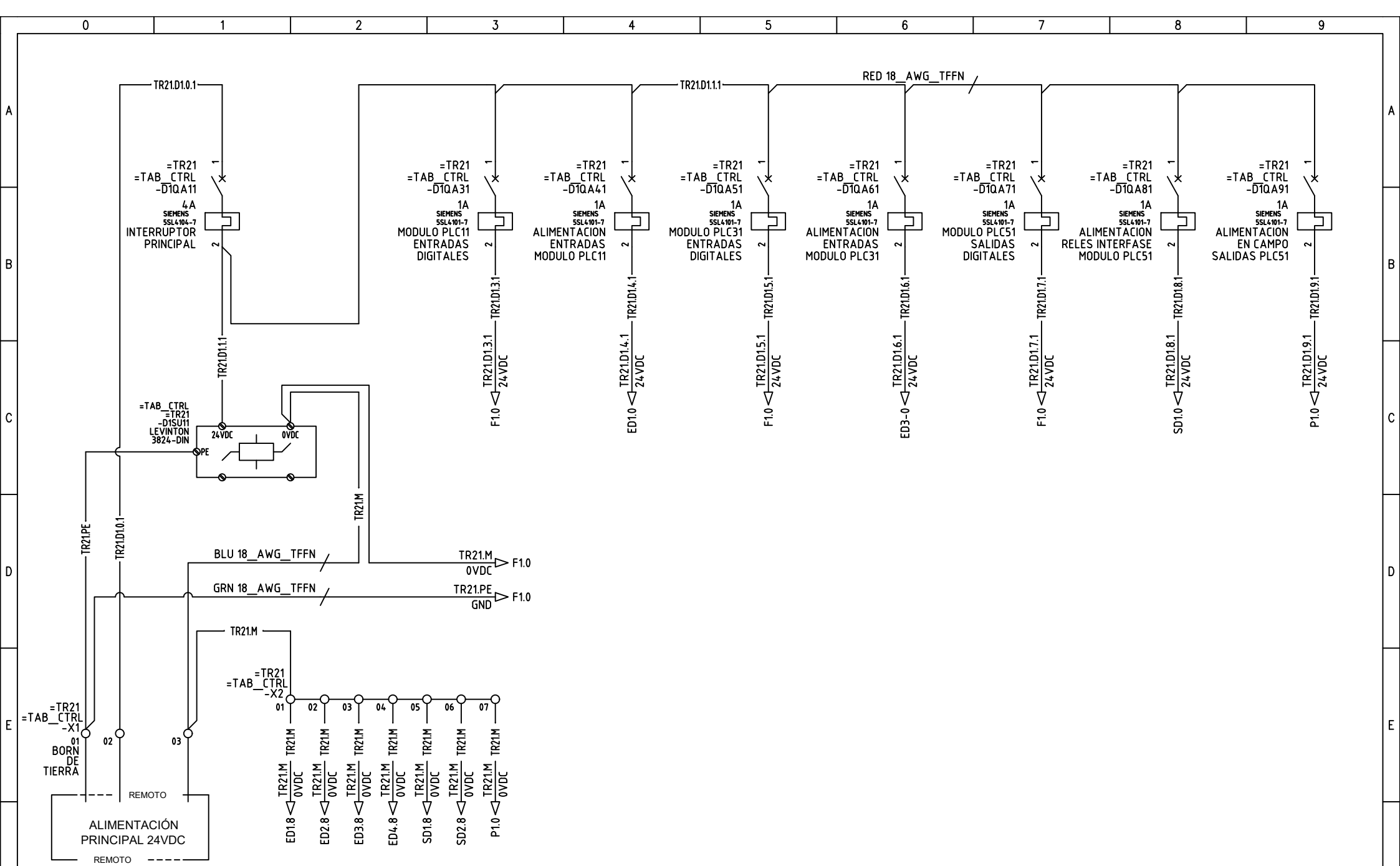

4				FECHA:	17/Mar/2020
3				DISEÑO:	L.F.G.G.
2				DIBUJÓ:	L.F.G.G.
1				REVISÓ:	J.D.A.H.
REV.	DESCRIPCIÓN	FECHA	NOMBRE	APROBÓ:	J.D.A.H.

ElicoGroup
 TEL: (+57 4) 4 44 74 41
 Cr. 48C # 100 Sur - 72
 La Estrella - Antioquia
 www.elicogrp.com

CONTIENE:	ALIMENTACIÓN PRINCIPAL 24VDC
PROYECTO:	AUTOMATIZACIÓN SILOS
CLIENTE:	SOCIEDAD PORTUARIA SANTA MARTA

IMPRESO:	20 marzo 2020
D1- ALIMENTACIÓN PRINCIPAL	
ANTERIOR:	J1 #ORDEN: OI20004
ESQUEMA:	D1 #REVISIÓN: 1
SIGUIENTE:	F1 TOTAL HOJAS: 20

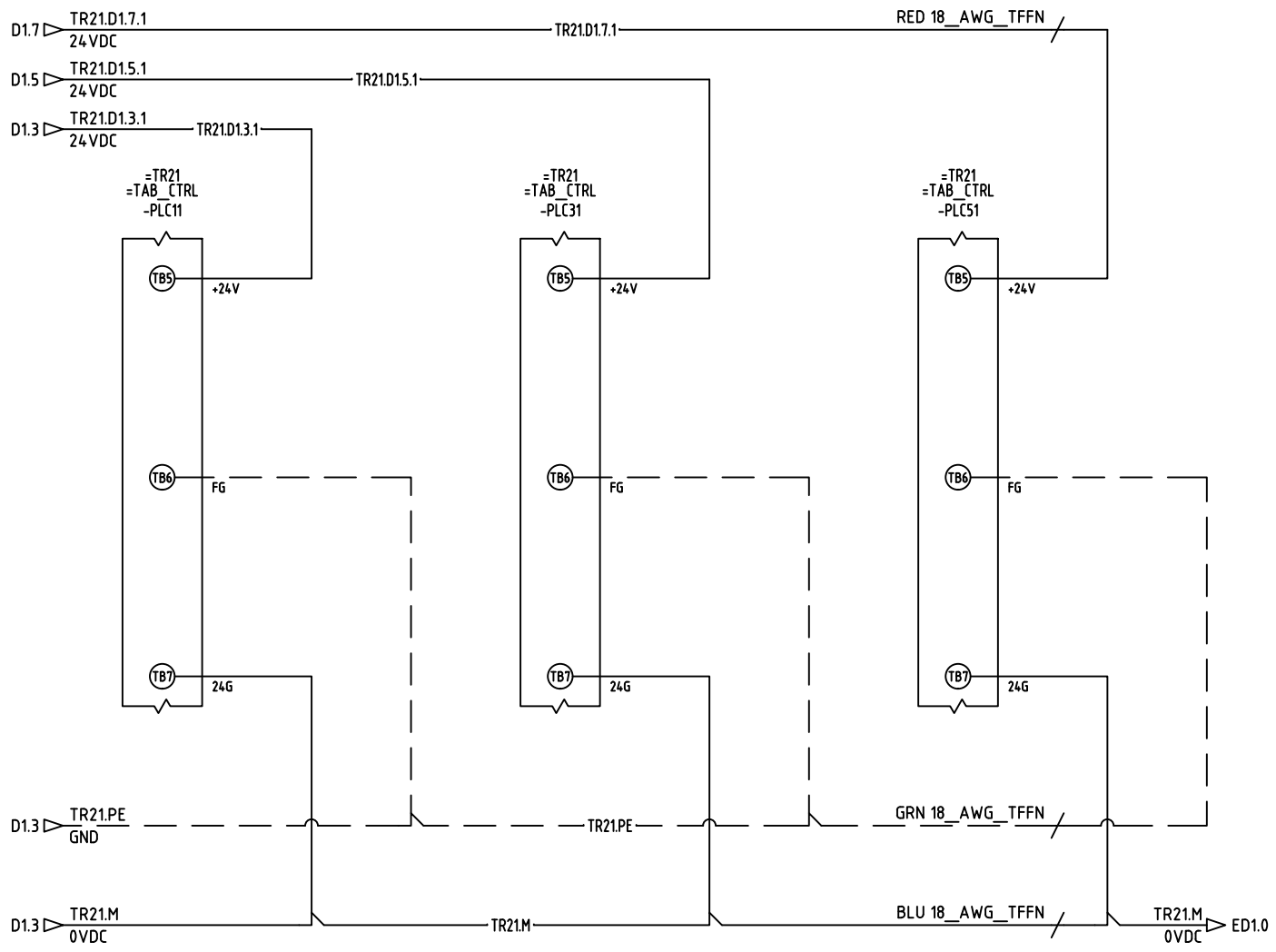

4			FECHA:	17/Mar/2020
3			DISEÑO:	L.F.G.G.
2			DIBUJÓ:	L.F.G.G.
1			REVISÓ:	J.D.A.H
REV.	DESCRIPCIÓN	FECHA	NOMBRE	APROBÓ:
			J.D.A.H	



 TEL: (+57 4) 4 44 74 41
 Cr. 48C # 100 Sur - 72
 La Estrella - Antioquia
 www.elicogrp.com

CONTIENE:	DISTRIBUCIÓN HARDWARE MÓDULOS PLC
PROYECTO:	AUTOMATIZACIÓN SILOS
CLIENTE:	SOCIEDAD PORTUARIA SANTA MARTA

IMPRESO: 20 marzo 2020	
F1- DISTRIBUCIÓN HARDWARE PLC	
ANTERIOR: D1	#ORDEN: 0I20004
ESQUEMA: F1	#REVISIÓN: 1
SIGUIENTE: G1	TOTAL HOJAS: 20

=TR21
=TAB CTRL
MITSUBISHI
AJ65BTB1-16D
ENTRADAS DIGITALES

24VDC SINK/SOURCE INPUTS

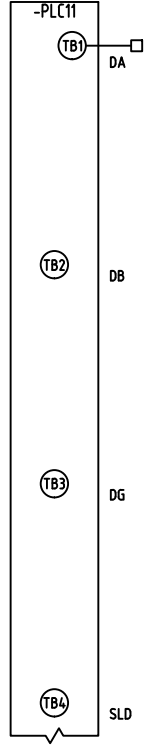

=TR21
=TAB CTRL
MITSUBISHI
AJ65BTB1-16D
ENTRADAS DIGITALES

24VDC SINK/SOURCE INPUTS

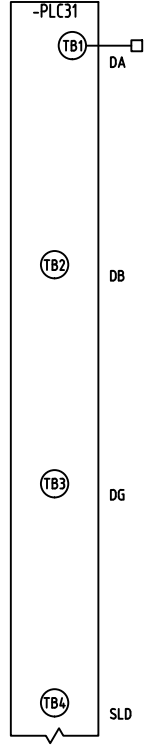

=TR21
=TAB CTRL
MITSUBISHI
AJ65BTB1-16T
SALIDAS DIGITALES

12/24VDC OUTPUTS

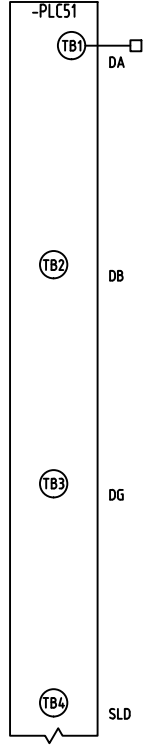

4				FECHA:	17/Mar/2020
3				DISEÑO:	L.F.G.G.
2				DIBUJÓ:	L.F.G.G.
1				REVISÓ:	J.D.A.H
REV.	DESCRIPCIÓN	FECHA	NOMBRE	APROBÓ:	J.D.A.H

TEL:(+57 4) 4 44 74 41
Cr. 48C # 100 Sur - 72
La Estrella - Antioquia
www.elicogrp.com

CONTIENE:	CONEXIÓN CC-LINK
PROYECTO:	AUTOMATIZACIÓN SILOS
CLIENTE:	SOCIEDAD PORTUARIA SANTA MARTA

IMPRESO: 20 marzo 2020	
G1- CONEXIÓN CC-LINK	
ANTERIOR: F1	#ORDEN: 0120004
ESQUEMA: G1	#REVISIÓN: 1
SIGUIENTE: ED1	TOTAL HOJAS: 20

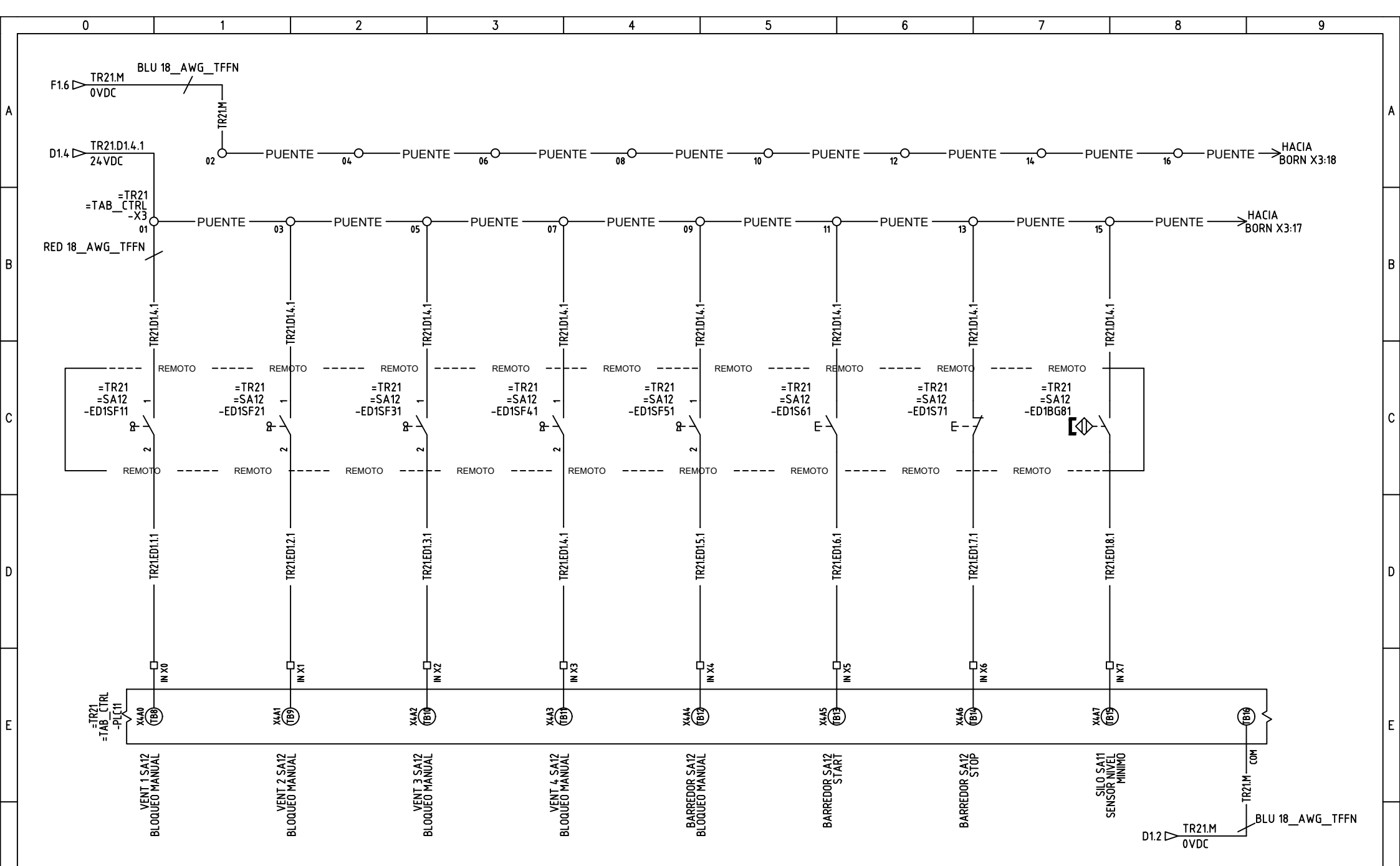

4				FECHA:	17/Mar/2020
3				DISEÑO:	L.F.G.G.
2				DIBUJÓ:	L.F.G.G.
1				REVISÓ:	J.D.A.H
REV.	DESCRIPCIÓN	FECHA	NOMBRE	APROBÓ:	J.D.A.H



 TEL: (+57 4) 4 44 74 41

 Cr. 48C # 100 Sur - 72

 La Estrella - Antioquia

 www.elicogrp.com

CONTIENE:	ENTRADAS DIGITALES MÓDULO 1 CC-LINK I/O 16 DC SNK/SCE INPUTS AJ65SBTB1-16D
PROYECTO:	AUTOMATIZACIÓN SILOS
CLIENTE:	SOCIEDAD PORTUARIA SANTA MARTA

IMPRESO:	20 marzo 2020
ED1- ENTRADAS DIGITALES	
ANTERIOR:	G1
ESQUEMA:	ED1
SIGUIENTE:	ED2
#ORDEN:	OI20004
#REVISIÓN:	1
TOTAL HOJAS:	020

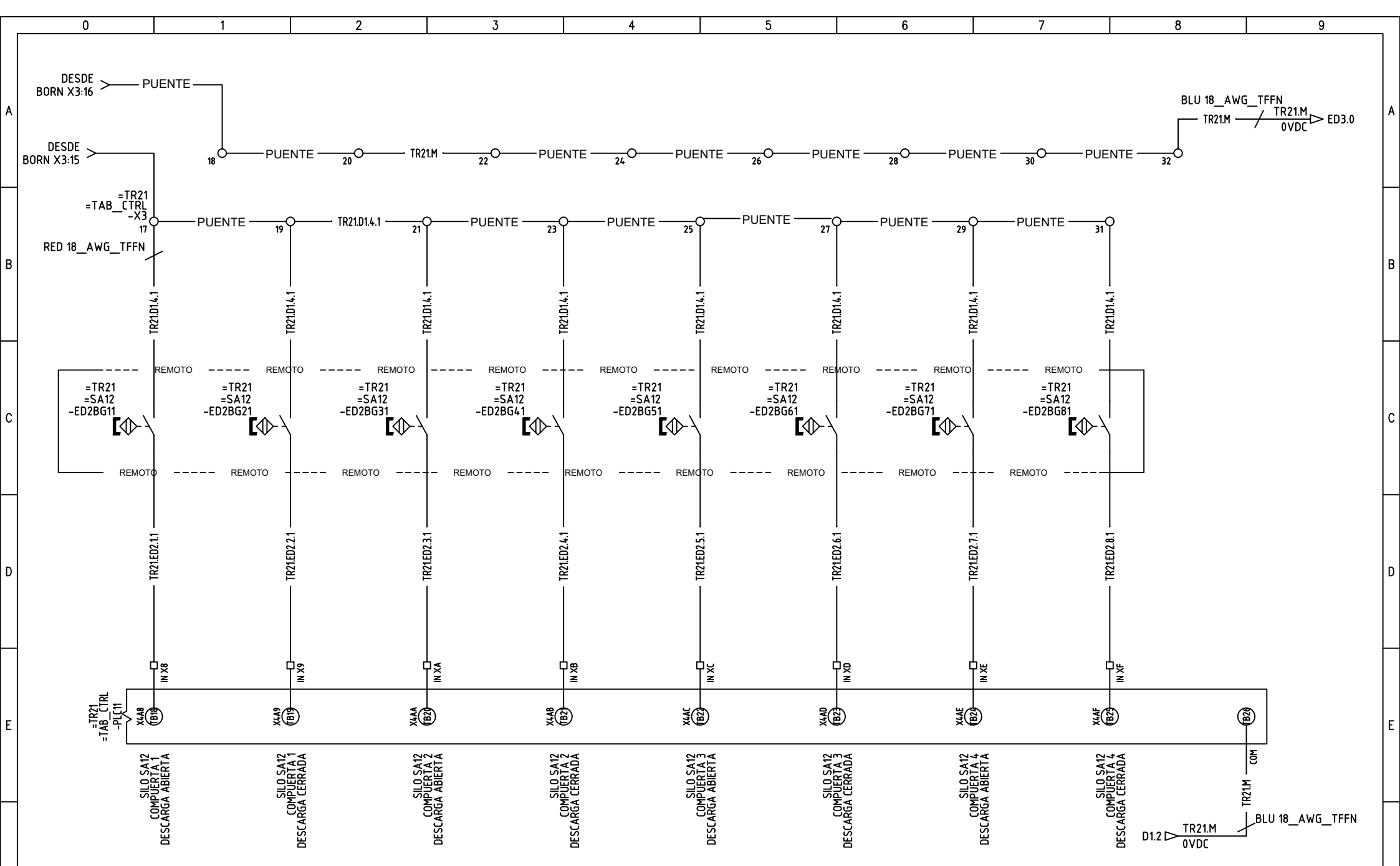

4			FECHA:	17/Mar/2020
3			DISEÑO:	L.F.G.G.
2			DIBUJÓ:	L.F.G.G.
1			REVISÓ:	J.D.A.H
REV.	DESCRIPCIÓN	FECHA	NOMBRE	APROBÓ:
			J.D.A.H	

ElicoGroup
 TEL: (+57 4) 4 44 74 41
 Cr. 48C # 100 Sur - 72
 La Estrella - Antioquia
 www.elicogrp.com

CONTIENE:	ENTRADAS DIGITALES MÓDULO 1 CC-LINK I/O 16 DC SNK/SCE INPUTS AJ65SBTB1-16D
PROYECTO:	AUTOMATIZACIÓN SILOS
CLIENTE:	SOCIEDAD PORTUARIA SANTA MARTA

IMPRESO:	20 marzo 2020
ED2- ENTRADAS DIGITALES	
ANTERIOR:	ED1
ESQUEMA:	ED2
SIGUIENTE:	ED3
#ORDEN:	OI20004
#REVISIÓN:	1
TOTAL HOJAS:	020

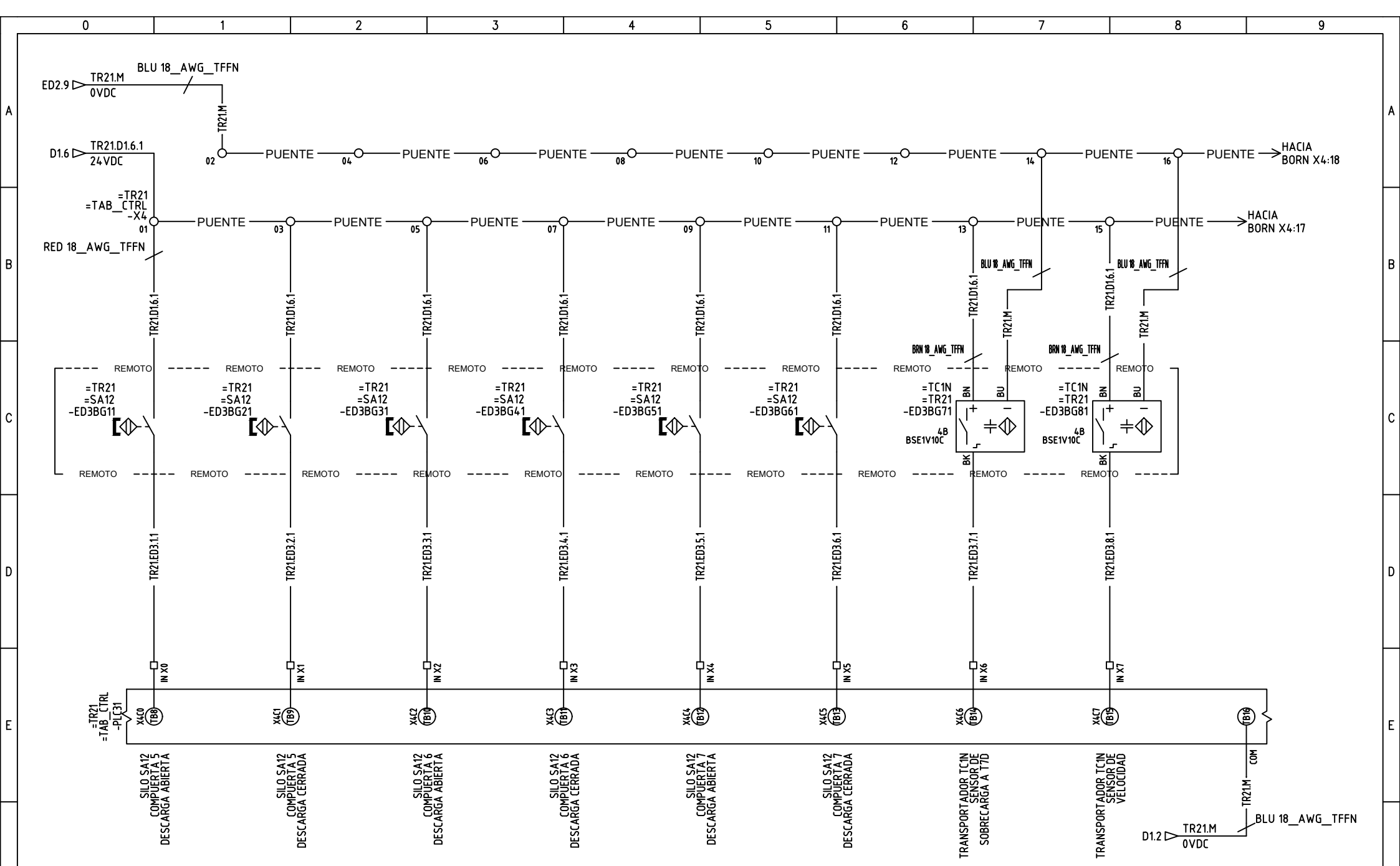

4			FECHA:	17/Mar/2020
3			DISEÑO:	L.F.G.G.
2			DIBUJÓ:	L.F.G.G.
1			REVISÓ:	J.D.A.H
REV.	DESCRIPCIÓN	FECHA	NOMBRE	APROBÓ:
			J.D.A.H	

ElicoGroup
 TEL: (+57 4) 4 44 74 41
 Cr. 48C # 100 Sur - 72
 La Estrella - Antioquia
 www.elicogrp.com

CONTIENE:	ENTRADAS DIGITALES MÓDULO 2 CC-LINK I/O 16 DC SNK/SCE INPUTS AJ65SBTB1-16D
PROYECTO:	AUTOMATIZACIÓN SILOS
CLIENTE:	SOCIEDAD PORTUARIA SANTA MARTA

IMPRESO:	20 marzo 2020
ED3- ENTRADAS DIGITALES	
ANTERIOR:	ED2
ESQUEMA:	ED3
SIGUIENTE:	ED4
#ORDEN:	OI20004
#REVISIÓN:	1
TOTAL HOJAS:	020

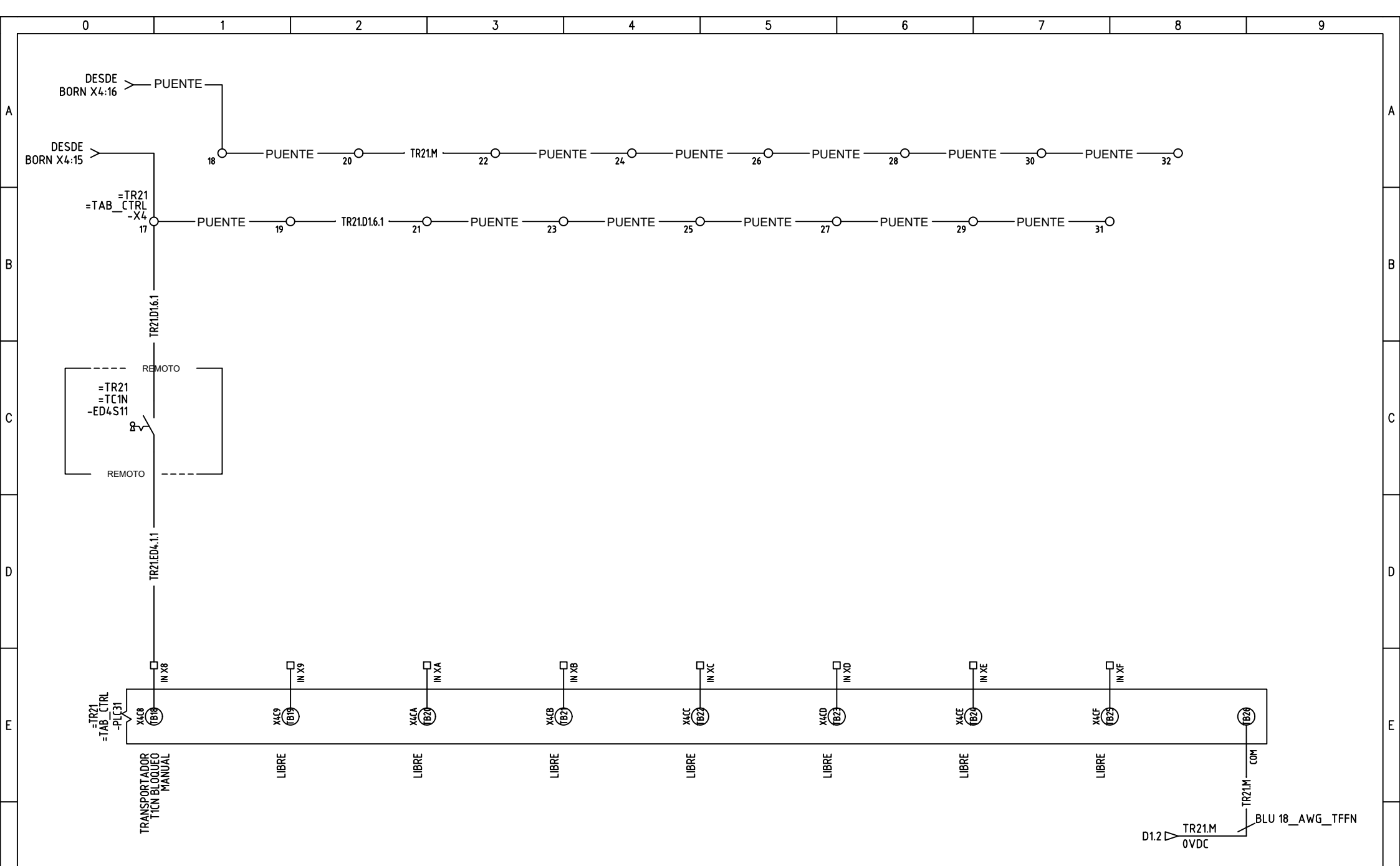

4				FECHA:	17/Mar/2020
3				DISEÑO:	L.F.G.G.
2				DIBUJÓ:	L.F.G.G.
1				REVISÓ:	J.D.A.H
REV.	DESCRIPCIÓN	FECHA	NOMBRE	APROBÓ:	J.D.A.H

ElicoGroup

TEL: (+57 4) 4 44 74 41
Cr. 48C # 100 Sur - 72
La Estrella - Antioquia
www.elicogrp.com

CONTIENE:	ENTRADAS DIGITALES MÓDULO 2 CC-LINK I/O 16 DC SNK/SCE INPUTS AJ65SBTB1-16D
PROYECTO:	AUTOMATIZACIÓN SILOS
CLIENTE:	SOCIEDAD PORTUARIA SANTA MARTA

IMPRESO: 20 marzo 2020	
ED4- ENTRADAS DIGITALES	
ANTERIOR: ED3	#ORDEN: 0120004
ESQUEMA: ED4	#REVISIÓN: 1
SIGUIENTE: SD1	TOTAL HOJAS: 020

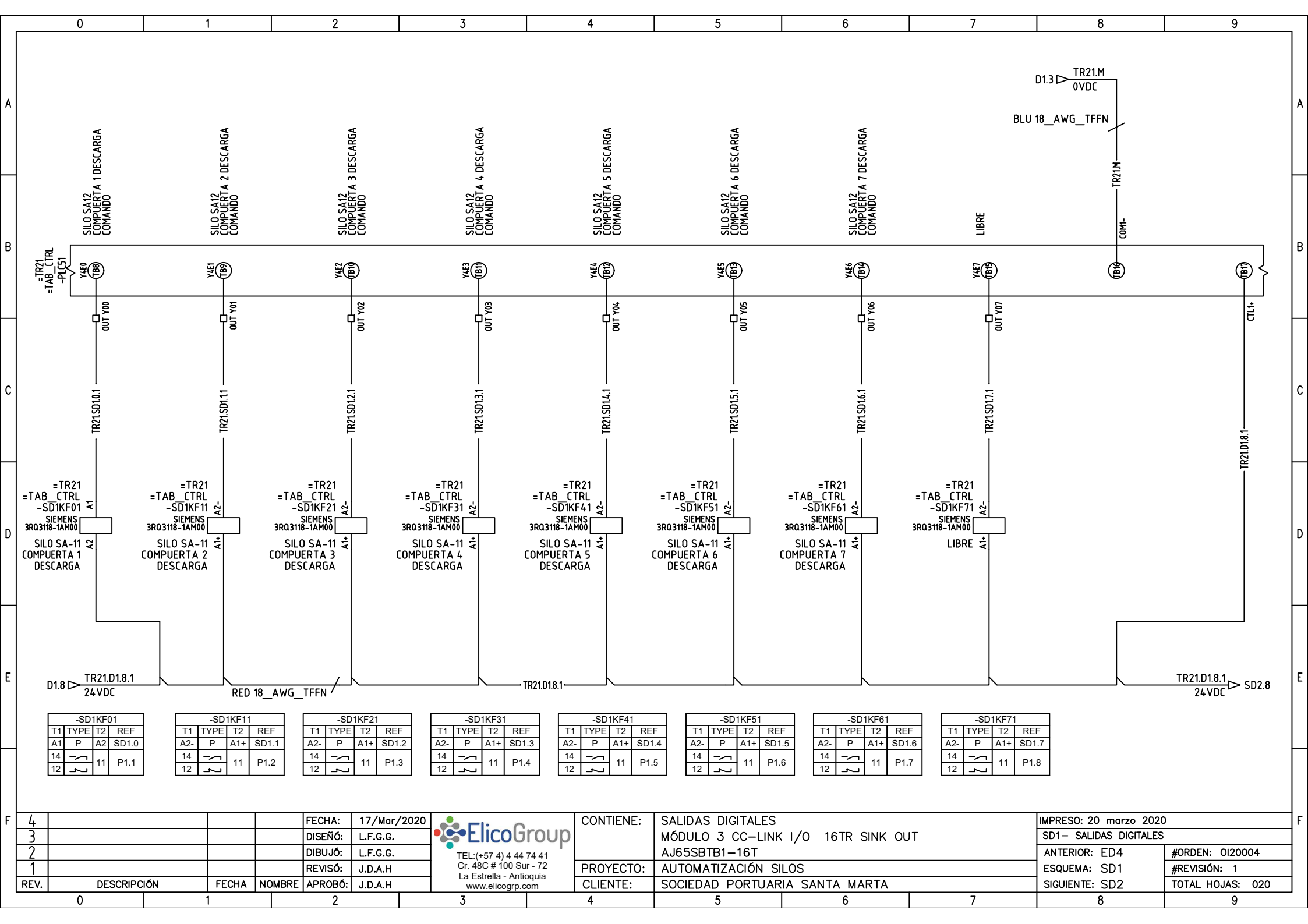

-SD1KF01			
T1	TYPE	T2	REF
A1	P	A2	SD1.0
14]	11	P1.1
12]		

-SD1KF11			
T1	TYPE	T2	REF
A2-	P	A1+	SD1.1
14]	11	P1.2
12]		

-SD1KF21			
T1	TYPE	T2	REF
A2-	P	A1+	SD1.2
14]	11	P1.3
12]		

-SD1KF31			
T1	TYPE	T2	REF
A2-	P	A1+	SD1.3
14]	11	P1.4
12]		

-SD1KF41			
T1	TYPE	T2	REF
A2-	P	A1+	SD1.4
14]	11	P1.5
12]		

-SD1KF51			
T1	TYPE	T2	REF
A2-	P	A1+	SD1.5
14]	11	P1.6
12]		

-SD1KF61			
T1	TYPE	T2	REF
A2-	P	A1+	SD1.6
14]	11	P1.7
12]		

-SD1KF71			
T1	TYPE	T2	REF
A2-	P	A1+	SD1.7
14]	11	P1.8
12]		

4				FECHA:	17/Mar/2020
3				DISEÑO:	L.F.G.G.
2				DIBUJÓ:	L.F.G.G.
1				REVISÓ:	J.D.A.H
REV.	DESCRIPCIÓN	FECHA	NOMBRE	APROBÓ:	J.D.A.H

ElicoGroup
 TEL: (+57 4) 4 44 74 41
 Cr. 48C # 100 Sur - 72
 La Estrella - Antioquia
 www.elicogrp.com

CONTIENE:	SALIDAS DIGITALES MÓDULO 3 CC-LINK I/O 16TR SINK OUT AJ65SBTB1-16T
PROYECTO:	AUTOMATIZACIÓN SILOS
CLIENTE:	SOCIEDAD PORTUARIA SANTA MARTA

IMPRESO:	20 marzo 2020
SD1- SALIDAS DIGITALES	
ANTERIOR:	ED4 #ORDEN: 0120004
ESQUEMA:	SD1 #REVISIÓN: 1
SIGUIENTE:	SD2 TOTAL HOJAS: 020

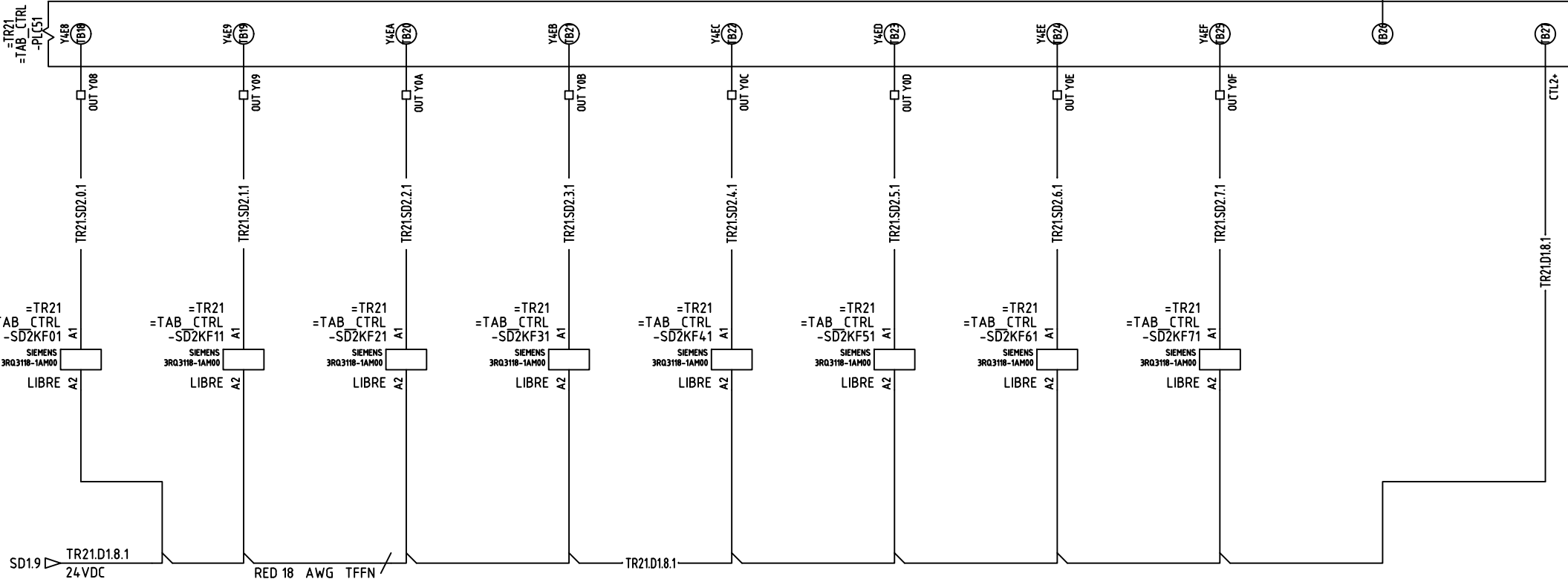
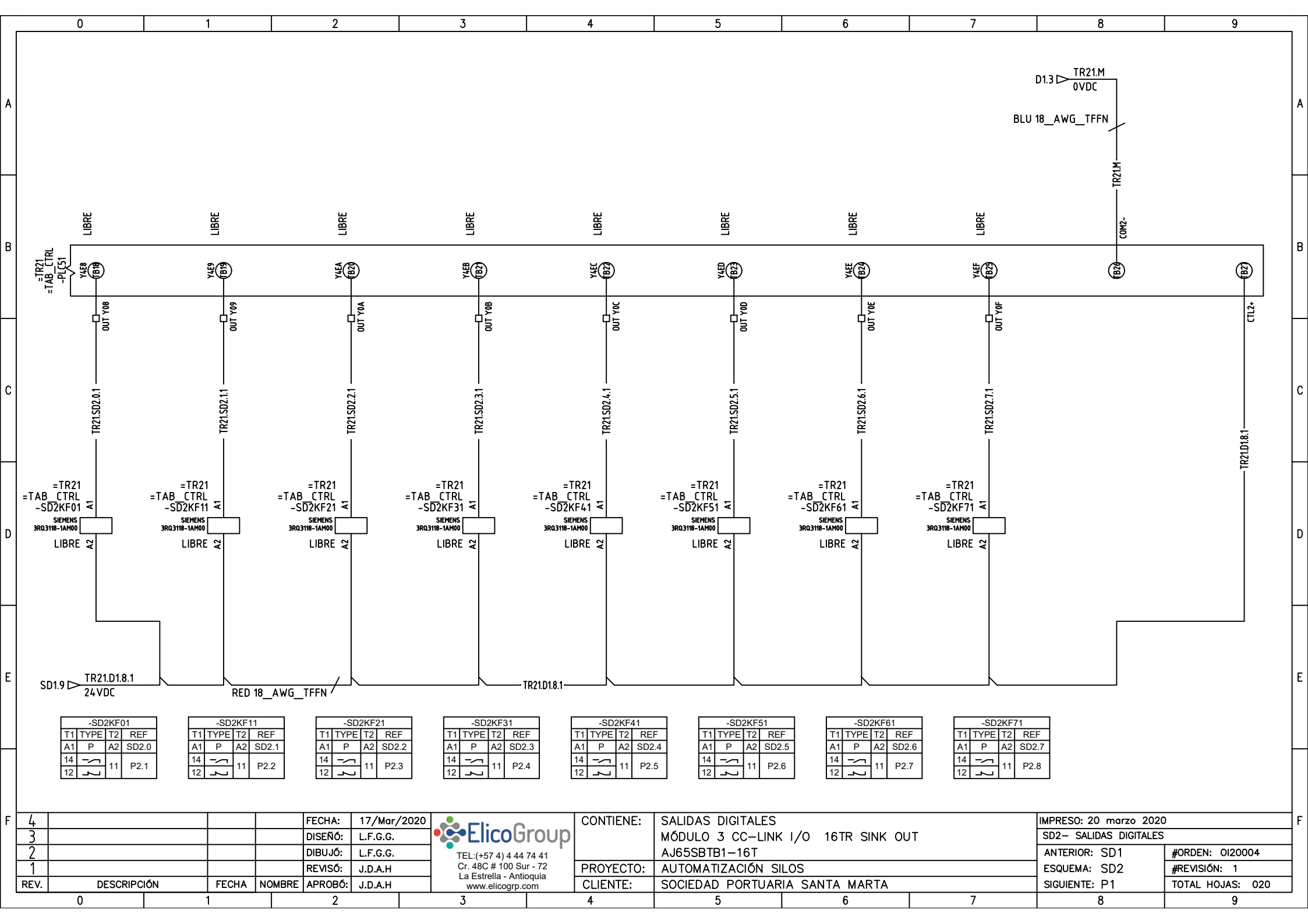

-SD2KF01			
T1	TYPE	T2	REF
A1	P	A2	SD2.0
14		11	P2.1
12			

-SD2KF11			
T1	TYPE	T2	REF
A1	P	A2	SD2.1
14		11	P2.2
12			

-SD2KF21			
T1	TYPE	T2	REF
A1	P	A2	SD2.2
14		11	P2.3
12			

-SD2KF31			
T1	TYPE	T2	REF
A1	P	A2	SD2.3
14		11	P2.4
12			

-SD2KF41			
T1	TYPE	T2	REF
A1	P	A2	SD2.4
14		11	P2.5
12			

-SD2KF51			
T1	TYPE	T2	REF
A1	P	A2	SD2.5
14		11	P2.6
12			

-SD2KF61			
T1	TYPE	T2	REF
A1	P	A2	SD2.6
14		11	P2.7
12			

-SD2KF71			
T1	TYPE	T2	REF
A1	P	A2	SD2.7
14		11	P2.8
12			

4				FECHA:	17/Mar/2020
3				DISEÑO:	L.F.G.G.
2				DIBUJÓ:	L.F.G.G.
1				REVISÓ:	J.D.A.H
REV.	DESCRIPCIÓN	FECHA	NOMBRE	APROBÓ:	J.D.A.H

ElicoGroup
 TEL: (+57 4) 4 44 74 41
 Cr. 48C # 100 Sur - 72
 La Estrella - Antioquia
 www.elicogrp.com

CONTIENE:	SALIDAS DIGITALES MÓDULO 3 CC-LINK I/O 16TR SINK OUT AJ65SBTB1-16T
PROYECTO:	AUTOMATIZACIÓN SILOS
CLIENTE:	SOCIEDAD PORTUARIA SANTA MARTA

IMPRESO:	20 marzo 2020
SD2- SALIDAS DIGITALES	
ANTERIOR:	SD1
ESQUEMA:	SD2
SIGUIENTE:	P1
#ORDEN:	OI20004
#REVISIÓN:	1
TOTAL HOJAS:	020

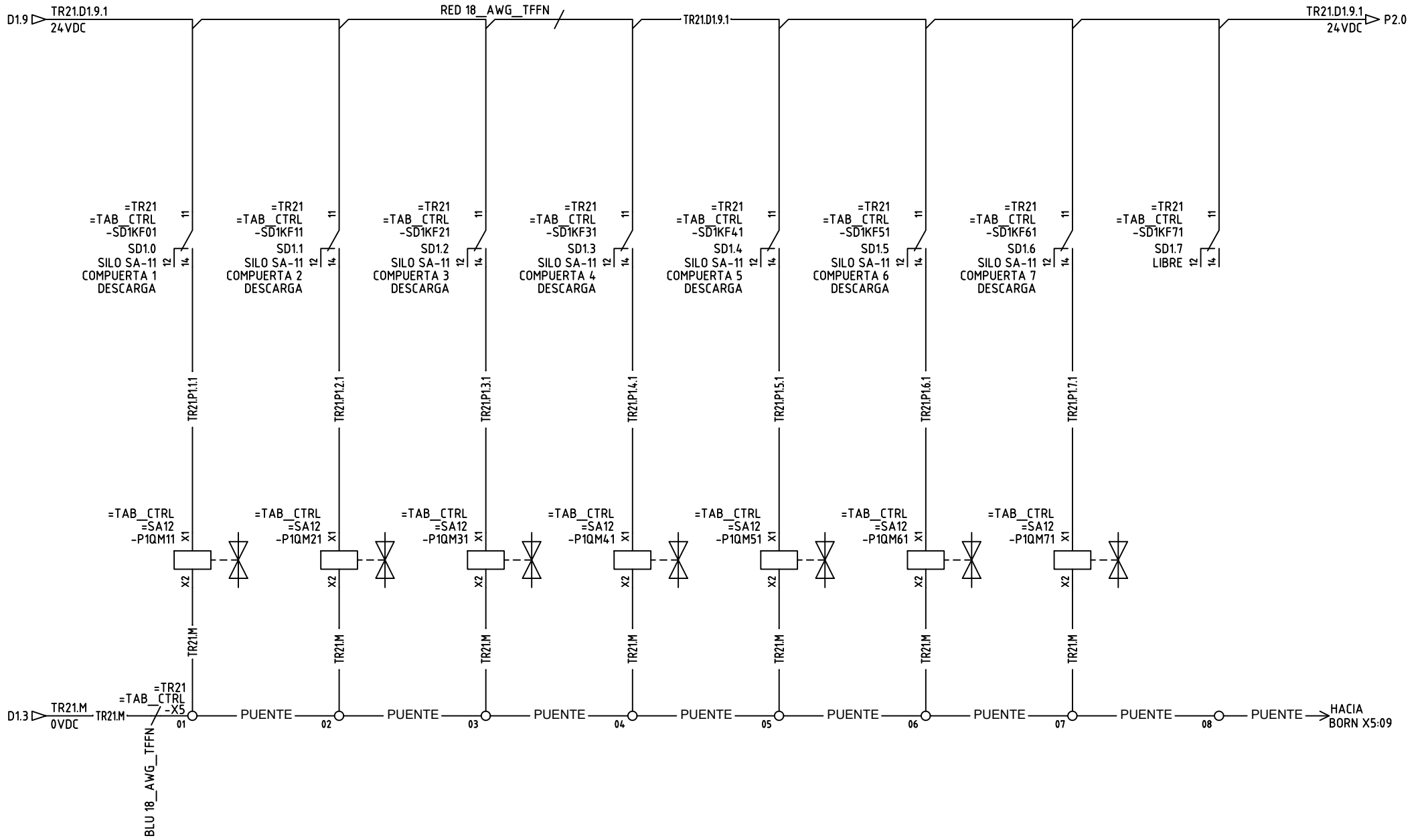

4				FECHA:	17/Mar/2020
3				DISEÑO:	L.F.G.G.
2				DIBUJÓ:	L.F.G.G.
1				REVISÓ:	J.D.A.H
REV.	DESCRIPCIÓN	FECHA	NOMBRE	APROBÓ:	J.D.A.H



 TEL: (+57 4) 4 44 74 41

 Cr. 48C # 100 Sur - 72

 La Estrella - Antioquia

 www.elicogrp.com

CONTIENE:	SALIDAS RELEVADAS 24VDC MÓDULO 3 PLC15
PROYECTO:	AUTOMATIZACIÓN SILOS
CLIENTE:	SOCIEDAD PORTUARIA SANTA MARTA

IMPRESO:	20 marzo 2020
P1- SALIDAS RELEVADAS	
ANTERIOR:	SD2
ESQUEMA:	P1
SIGUIENTE:	P2
#ORDEN:	OI20004
#REVISIÓN:	1
TOTAL HOJAS:	20

A

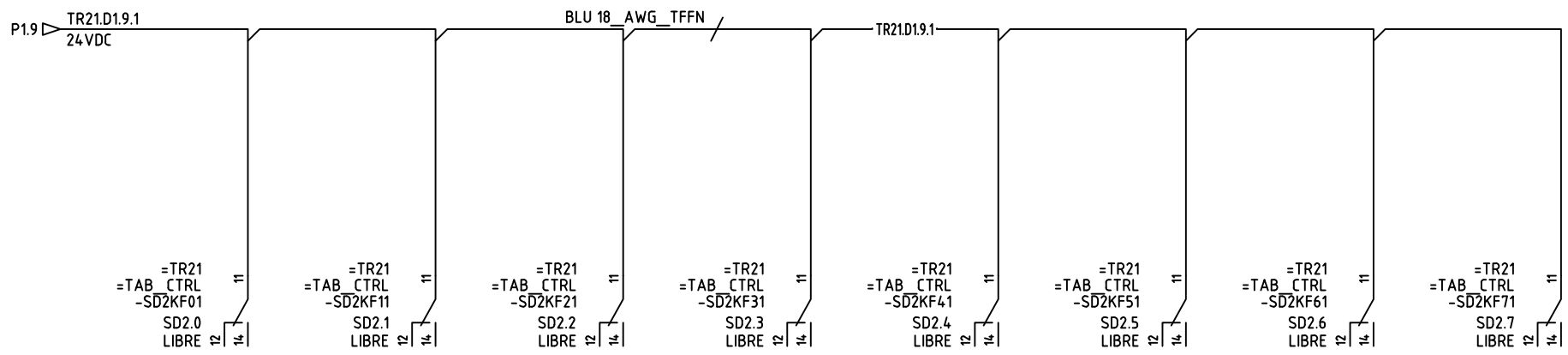

B

C

D

E

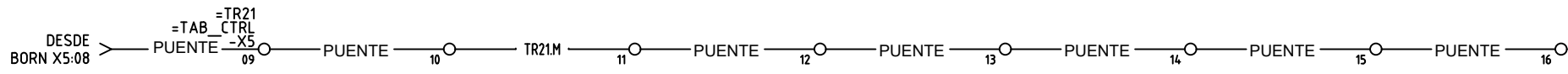

F

4				FECHA:	17/Mar/2020
3				DISEÑO:	L.F.G.G.
2				DIBUJÓ:	L.F.G.G.
1				REVISÓ:	J.D.A.H
REV.	DESCRIPCIÓN	FECHA	NOMBRE	APROBÓ:	J.D.A.H

TEL: (+57 4) 4 44 74 41
Cr. 48C # 100 Sur - 72
La Estrella - Antioquia
www.elicogr.com

CONTIENE:	SALIDAS RELEVADAS 24VDC MÓDULO 3 PLC15
PROYECTO:	AUTOMATIZACIÓN SILOS
CLIENTE:	SOCIEDAD PORTUARIA SANTA MARTA

IMPRESO: 20 marzo 2020	
P2- SALIDAS RELEVADAS	
ANTERIOR: P1	#ORDEN: 0120004
ESQUEMA: P2	#REVISIÓN: 1
SIGUIENTE: L1	TOTAL HOJAS: 20

ETIQUETAS	CTDAD	SUB	CATÁLOGO	FABRI	DESCRIPCIÓN
-D1QA31 -D1QA41 -D1QA51 -D1QA61 -D1QA71 -D1QA81 -D1QA91	7		5SL4101-7	SIEMENS	MINIATURE CIRCUIT BREAKER 5SL, 10KA 1-POLE CIRCUIT BREAKER 1AMPS THERMAL AND FIXED MAGNETIC TRIP 230VAC
-D1QA11	1		5SL4104-7	SIEMENS	Automático magnetotérmico MINI BREAKER CIRCUIT, 1 POLE, C, 10KA 4A 230/400V
-SD2KF01 -SD2KF11 -SD2KF21 -SD2KF31 -SD2KF41 -SD2KF51 -SD2KF61 -SD2KF71	8		39.31.0.024.0060	FINDER	
-SD1KF01 -SD1KF11 -SD1KF21 -SD1KF31 -SD1KF41 -SD1KF51 -SD1KF61 -SD1KF71	8		3RQ3118-1AM00	SIEMENS	Relés de interfaz de entrada con bornes relé 1 conmutado borne de tornillo AC/DC 24 VDC / Corriente térmica 6A
-PLC11 -PLC31	2		AJ65BTB1-16D	MITSUBISHI	MELSEC A DISCRETE INPUT MODULE MELSEC A DISCRETE INPUT 24VDC 16 POINTS, SINK/SOURCE
-PLC51	1		AJ65BTB1-16T	MITSUBISHI	MELSEC A DISCRETE OUTPUT MODULE MELSEC A DISCRETE OUTPUT 12/24VDC 16 POINTS
-ED3BG71 -ED3BG81	2		BSE1V10C	4B	
-D1SU11	1		3824-DIN	LEVINTON	
-X5	1		3030213	PHOENIX CONTACT	PLUG-IN BRIDGE JUMP 50.6 mm, number of positions: 10, color: red FBS10-5 BORNE DE PASO Conexión push-in 24A 0,14 mm² - 4 mm², AWG: 26 - 12 anchura: 5,2 mm, altura: 35,3 mm, color: gris, clase de montaje: NS 35/7,5, NS 35/15
-X1 -X2	9		3209510	PHOENIX CONTACT	Borne de tierra para carril Conexión push-in PA 6KV número de conexiones: 2, sección: 0,14 mm² - 4 mm², AWG: 26 - 12 ancho: 5,2 mm, alto: 35,3 mm, amarillo-verde
-X1	1		3209536	PHOENIX CONTACT	Borne de doble piso Conexión push-in sección: 0,14 mm² - 4 mm², AWG: 26 - 12 anchura: 5,2 mm, color: gris clase de montaje: NS 35/7,5, NS 35/15
-X3 -X4	16		3210567	PHOENIX CONTACT	

4				FECHA:	17/Mar/2020
3				DISEÑO:	L.F.G.G.
2				DIBUJÓ:	L.F.G.G.
1				REVISÓ:	J.D.A.H
REV.	DESCRIPCIÓN	FECHA	NOMBRE	APROBÓ:	J.D.A.H



TEL: (+57 4) 4 44 74 41
Cr. 48C # 100 Sur - 72
La Estrella - Antioquia
www.elicogrp.com

CONTIENE:	LISTA DE MATERIALES
PROYECTO:	AUTOMATIZACIÓN SILOS
CLIENTE:	SOCIEDAD PORTUARIA SANTA MARTA

IMPRESO:	20 marzo 2020
LISTA DE MATERIALES_L1	
ANTERIOR:	P2 #ORDEN: 0120004
ESQUEMA:	L1 #REVISIÓN: 1
SIGUIENTE:	L2 TOTAL HOJAS: 20

ETIQUETAS	CTDAD	SUB	CATÁLOGO	FABRI	DESCRIPCIÓN
-X3 -X4	16		3210567	PHOENIX CONTACT	Borne de doble piso Conexión push-in sección: 0,14 mm² - 4 mm², AWG: 26 - 12 anchura: 5,2 mm, color: gris clase de montaje: NS 35/7,5, NS 35/15
-X5	8		3210567	PHOENIX CONTACT	Borne de doble piso Conexión push-in sección: 0,14 mm² - 4 mm², AWG: 26 - 12 anchura: 5,2 mm, color: gris clase de montaje: NS 35/7,5, NS 35/15

4				FECHA:	17/Mar/2020
3				DISEÑO:	L.F.G.G.
2				DIBUJÓ:	L.F.G.G.
1				REVISÓ:	J.D.A.H
REV.	DESCRIPCIÓN	FECHA	NOMBRE	APROBÓ:	J.D.A.H



TEL: (+57 4) 4 44 74 41
Cr. 48C # 100 Sur - 72
La Estrella - Antioquia
www.elicogrp.com

CONTIENE:		IMPRESO: 20 marzo 2020
		LISTA DE MATERIALES_L2
PROYECTO:	AUTOMATIZACIÓN SILOS	ANTERIOR: L1 #ORDEN: 0I20004
CLIENTE:	SOCIEDAD PORTUARIA SANTA MARTA	ESQUEMA: L2 #REVISIÓN: 1
		SIGUIENTE: K1 TOTAL HOJAS: 20

GRUPO DE BORN X1: ALIMENTACIÓN PRINCIPAL 24VDC													
Dispositivo1	Polo1	Cable1	Tipo1	T1	Número	T2	Fabricante	Catálogo	Tipo2	Cable2	Polo2	Dispositivo2	Puente
					1		PHOENIX CONTACT	3022218					
-D1SU11	PE	TR21.PE	GRN_18_AWG_T_FFN		01		PHOENIX CONTACT	3209536	GRN_18_AWG_T_FFN	TR21.PE			○ ○ ○
-PLC11	TB6	TR21.PE	GRN_18_AWG_T_FFN		01								○ ○ ○
-D1QA11	1	TR21.D1.0.1	RED_18_AWG_TF_FFN		02		PHOENIX CONTACT	3209510	RED_18_AWG_TF_FFN	TR21.D1.0.1			○ ○ ○
-D1SU11	0VDC	TR21.M	BLU_18_AWG_TF_FFN		03		PHOENIX CONTACT	3209510	BLU_18_AWG_TF_FFN	TR21.M	01	-X2	● ○ ○ ○ ○ ○
					1		PHOENIX CONTACT	3030417					
					1		PHOENIX CONTACT	3022218					

4				FECHA:	17/Mar/2020
3				DISEÑO:	L.F.G.G.
2				DIBUJÓ:	L.F.G.G.
1				REVISÓ:	J.D.A.H
REV.	DESCRIPCIÓN	FECHA	NOMBRE	APROBÓ:	J.D.A.H



TEL: (+57 4) 4 44 74 41
Cr. 48C # 100 Sur - 72
La Estrella - Antioquia
www.elicogrp.com

CONTIENE:	LISTADO DE BORNERAS
PROYECTO:	AUTOMATIZACIÓN SILOS
CLIENTE:	SOCIEDAD PORTUARIA SANTA MARTA

IMPRESO: 20 marzo 2020	
LISTADO DE BORNERAS_K1	
ANTERIOR: L2	#ORDEN: 0120004
ESQUEMA: K1	#REVISIÓN: 1
SIGUIENTE: K2	TOTAL HOJAS: 20

GRUPO DE BORN X2: COMÚN 0VDC													
Dispositivo1	Polo1	Cable1	Tipo1	T1	Número	T2	Fabricante	Catálogo	Tipo2	Cable2	Polo2	Dispositivo2	Puente
					1		PHOENIX CONTACT	3022218					
-X1	03	TR21.M	BLU_18_AWG_TF_FN		01		PHOENIX CONTACT	3209510	BLU_18_AWG_TF_FN	TR21.M	TB16	-PLC11	○ ○ ○
-PLC11	TB26	TR21.M	BLU_18_AWG_TF_FN		02		PHOENIX CONTACT	3209510					○ ○ ○
-PLC31	TB16	TR21.M	BLU_18_AWG_TF_FN		03		PHOENIX CONTACT	3209510					○ ○ ○
-PLC31	TB26	TR21.M	BLU_18_AWG_TF_FN		04		PHOENIX CONTACT	3209510					○ ○ ○
-PLC51	TB16	TR21.M	BLU_18_AWG_TF_FN		05		PHOENIX CONTACT	3209510					○ ○ ○
-?-PLC51	TB26	TR21.M	BLU_18_AWG_TF_FN		06		PHOENIX CONTACT	3209510					○ ○ ○
-X5	01	TR21.M	BLU_18_AWG_TF_FN		07		PHOENIX CONTACT	3209510					○ ○ ○
					1		PHOENIX CONTACT	3030417					
					1		PHOENIX CONTACT	3022218					

4				FECHA:	17/Mar/2020
3				DISEÑO:	L.F.G.G.
2				DIBUJÓ:	L.F.G.G.
1				REVISÓ:	J.D.A.H
REV.	DESCRIPCIÓN	FECHA	NOMBRE	APROBÓ:	J.D.A.H



TEL: (+57 4) 4 44 74 41
Cr. 48C # 100 Sur - 72
La Estrella - Antioquia
www.elicogrp.com

CONTIENE:	LISTADO DE BORNERAS
PROYECTO:	AUTOMATIZACIÓN SILOS
CLIENTE:	SOCIEDAD PORTUARIA SANTA MARTA

IMPRESO: 20 marzo 2020	
LISTADO DE BORNERAS_K2	
ANTERIOR: K1	#ORDEN: 0120004
ESQUEMA: K2	#REVISIÓN: 1
SIGUIENTE: K3	TOTAL HOJAS: 20

GRUPO DE BORN X3: COMUNES ENTRADAS DIGITALES													
Dispositivo1	Polo1	Cable1	Tipo1	T1	Número	T2	Fabricante	Catálogo	Tipo2	Cable2	Polo2	Dispositivo2	Puente
-D1QA41	2	TR21.D1.4.1	RED_1 8_AWG G_TFF N		01		PHOENIX CONTACT	3210567	RED_1 8_AWG G_TFF N	TR21.D1.4.1	1	-ED1SF11	○ ○ ○
-PLC51	TB7	TR21.M	BLU_1 8_AWG G_TFF N		02								○ ○ ○
-ED1SF21	1	TR21.D1.4.1	RED_1 8_AWG G_TFF N		03		PHOENIX CONTACT	3210567					○ ○ ○
					04								○ ○ ○
-ED1SF31	1	TR21.D1.4.1	RED_1 8_AWG G_TFF N		05		PHOENIX CONTACT	3210567					○ ○ ○
					06								○ ○ ○
-ED1SF41	1	TR21.D1.4.1	RED_1 8_AWG G_TFF N		07		PHOENIX CONTACT	3210567					○ ○ ○
					08								○ ○ ○
-ED1SF51	1	TR21.D1.4.1	RED_1 8_AWG G_TFF N		09		PHOENIX CONTACT	3210567					○ ○ ○
					10								○ ○ ○
-ED1S61		TR21.D1.4.1	RED_1 8_AWG G_TFF N		11		PHOENIX CONTACT	3210567					○ ○ ○
					12								○ ○ ○
-ED1S71		TR21.D1.4.1	RED_1 8_AWG G_TFF N		13		PHOENIX CONTACT	3210567					○ ○ ○
					14								○ ○ ○
-ED1BG81		TR21.D1.4.1	RED_1 8_AWG G_TFF N		15		PHOENIX CONTACT	3210567					○ ○ ○
					16								○ ○ ○
-ED2BG11		TR21.D1.4.1	RED_1 8_AWG G_TFF N		17		PHOENIX CONTACT	3210567					○ ○ ○
					18								○ ○ ○
-ED2BG21		TR21.D1.4.1	RED_1 8_AWG G_TFF N		19		PHOENIX CONTACT	3210567	RED_1 8_AWG G_TFF N	TR21.D1.4.1	21	-X3	○ ○ ○
-X3	22	TR21.M	BLU_1 8_AWG G_TFF N		20								○ ○ ○

GRUPO DE BORN X3: COMUNES ENTRADAS DIGITALES													
Dispositivo1	Polo1	Cable1	Tipo1	T1	Número	T2	Fabricante	Catálogo	Tipo2	Cable2	Polo2	Dispositivo2	Puente
-X3	19	TR21.D1.4.1	RED_1 8_AWG TFFN		21		PHOENIX CONTACT	3210567	RED_1 8_AWG TFFN	TR21.D1.4.1		-ED2BG31	○ ○ ○
-X3	20	TR21.M	BLU_1 8_AWG TFFN		22								○ ○ ○
-ED2BG41		TR21.D1.4.1	RED_1 8_AWG TFFN		23		PHOENIX CONTACT	3210567					○ ○ ○
					24								○ ○ ○
-ED2BG51		TR21.D1.4.1	RED_1 8_AWG TFFN		25		PHOENIX CONTACT	3210567					○ ○ ○
					26								○ ○ ○
-ED2BG61		TR21.D1.4.1	RED_1 8_AWG TFFN		27		PHOENIX CONTACT	3210567					○ ○ ○
					28								○ ○ ○
-ED2BG71		TR21.D1.4.1	RED_1 8_AWG TFFN		29		PHOENIX CONTACT	3210567					○ ○ ○
					30								○ ○ ○
-ED2BG81		TR21.D1.4.1	RED_1 8_AWG TFFN		31		PHOENIX CONTACT	3210567					○ ○ ○
-X4	02	TR21.M	BLU_1 8_AWG TFFN		32								○ ○ ○

4				FECHA:	17/Mar/2020
3				DISEÑO:	L.F.G.G.
2				DIBUJÓ:	L.F.G.G.
1				REVISÓ:	J.D.A.H
REV.	DESCRIPCIÓN	FECHA	NOMBRE	APROBÓ:	J.D.A.H



CONTIENE:	LISTADO DE BORNERAS	IMPRESO: 20 marzo 2020
PROYECTO:	AUTOMATIZACIÓN SILOS	LISTADO DE BORNERAS_K3
CLIENTE:	SOCIEDAD PORTUARIA SANTA MARTA	ANTERIOR: K2 #ORDEN: 0120004
		ESQUEMA: K3 #REVISIÓN: 1
		SIGUIENTE: K4 TOTAL HOJAS: 20

GRUPO DE BORN X4: COMUNES ENTRADAS DIGITALES												
Dispositivo1	Polo1	Cable1	Tipo1	T1	Número	T2	Fabricante	Catálogo	Tipo2	Cable2	Polo2	Puente
					1		PHOENIX CONTACT	3022218				
-D1QA61	2	TR21.D1.6.1	RED_1 8_AWG _TFFN		01		PHOENIX CONTACT	3210567	RED_1 8_AWG _TFFN	TR21.D1.6.1		-ED3BG11
-X3	32	TR21.M	BLU_18 _AWG _TFFN		02							
-ED3BG21		TR21.D1.6.1	RED_1 8_AWG _TFFN		03		PHOENIX CONTACT	3210567				
					04							
-ED3BG31		TR21.D1.6.1	RED_1 8_AWG _TFFN		05		PHOENIX CONTACT	3210567				
					06							
-ED3BG41		TR21.D1.6.1	RED_1 8_AWG _TFFN		07		PHOENIX CONTACT	3210567				
					08							
-ED3BG51		TR21.D1.6.1	RED_1 8_AWG _TFFN		09		PHOENIX CONTACT	3210567				
					10							
-ED3BG61		TR21.D1.6.1	RED_1 8_AWG _TFFN		11		PHOENIX CONTACT	3210567				
					12							
-ED3BG71	BN	TR21.D1.6.1	BRN_1 8_AWG _THHN		13		PHOENIX CONTACT	3210567				
-ED3BG71	BU	TR21.M	BLU_18 _AWG _TFFN		14							
-ED3BG81	BN	TR21.D1.6.1	BRN_1 8_AWG _THHN		15		PHOENIX CONTACT	3210567				
-ED3BG81	BU	TR21.M	BLU_18 _AWG _TFFN		16							
-ED4S11		TR21.D1.6.1	RED_1 8_AWG _TFFN		17		PHOENIX CONTACT	3210567				
					18							

GRUPO DE BORN X4: COMUNES ENTRADAS DIGITALES												
Dispositivo1	Polo1	Cable1	Tipo1	T1	Número	T2	Fabricante	Catálogo	Tipo2	Cable2	Polo2	Puente
-X4	21	TR21.D1.6.1	RED_1 8_AWG _TFFN		19		PHOENIX CONTACT	3210567				
-X4	22	TR21.M	BLU_18 _AWG _TFFN		20							
-X4	19	TR21.D1.6.1	RED_1 8_AWG _TFFN		21		PHOENIX CONTACT	3210567				
-X4	20	TR21.M	BLU_18 _AWG _TFFN		22							
					23		PHOENIX CONTACT	3210567				
					24		PHOENIX CONTACT	3210567				
					25		PHOENIX CONTACT	3210567				
					26		PHOENIX CONTACT	3210567				
					27		PHOENIX CONTACT	3210567				
					28		PHOENIX CONTACT	3210567				
					29		PHOENIX CONTACT	3210567				
					30		PHOENIX CONTACT	3210567				
					31		PHOENIX CONTACT	3210567				
					32		PHOENIX CONTACT	3210567				
					1		PHOENIX CONTACT	3211634				
					1		PHOENIX CONTACT	3022218				

4				FECHA:	17/Mar/2020
3				DISEÑO:	L.F.G.G.
2				DIBUJÓ:	L.F.G.G.
1				REVISÓ:	J.D.A.H
REV.	DESCRIPCIÓN	FECHA	NOMBRE	APROBÓ:	J.D.A.H



CONTIENE:	LISTADO DE BORNERAS
PROYECTO:	AUTOMATIZACIÓN SILOS
CLIENTE:	SOCIEDAD PORTUARIA SANTA MARTA

IMPRESO: 20 marzo 2020
LISTADO DE BORNERAS_K4
ANTERIOR: K3 #ORDEN: 0120004
ESQUEMA: K4 #REVISIÓN: 1
SIGUIENTE: K5 TOTAL HOJAS: 20

GRUPO DE BORN X5: SALIDAS RELEVADAS													
Dispositivo1	Polo1	Cable1	Tipo1	T1	Número	T2	Fabricante	Catálogo	Tipo2	Cable2	Polo2	Dispositivo2	Puente
					1		PHOENIX CONTACT	3022218					
-X2	07	TR21.M	BLU_18_AWG_TF FN		01		PHOENIX CONTACT	3210567	BLU_18_AWG_TF FN	TR21.M	X2	-P1QM11	● ○ ○
-P1QM21	X2	TR21.M	BLU_18_AWG_TF FN		02								● ○ ○
-P1QM31	X2	TR21.M	BLU_18_AWG_TF FN		03		PHOENIX CONTACT	3210567					● ○ ○
-P1QM41	X2	TR21.M	BLU_18_AWG_TF FN		04								● ○ ○
-P1QM51	X2	TR21.M	BLU_18_AWG_TF FN		05		PHOENIX CONTACT	3210567					● ○ ○
-P1QM61	X2	TR21.M	BLU_18_AWG_TF FN		06								● ○ ○
-P1QM71	X2	TR21.M	BLU_18_AWG_TF FN		07		PHOENIX CONTACT	3210567					● ○ ○
					08								● ○ ○
					09		PHOENIX CONTACT	3210567					● ○ ○
-X5	11	TR21.M	BLU_18_AWG_TF FN		10								● ○ ○
-X5	10	TR21.M	BLU_18_AWG_TF FN		11		PHOENIX CONTACT	3210567					● ○ ○
					12								● ○ ○
					13		PHOENIX CONTACT	3210567					● ○ ○
					14								● ○ ○
					15		PHOENIX CONTACT	3210567					● ○ ○
					16								● ○ ○
					1		PHOENIX CONTACT	3022218					● ○ ○
					1		PHOENIX CONTACT	3211634					● ○ ○

4				FECHA:	17/Mar/2020
3				DISEÑO:	L.F.G.G.
2				DIBUJÓ:	L.F.G.G.
1				REVISÓ:	J.D.A.H
REV.	DESCRIPCIÓN	FECHA	NOMBRE	APROBÓ:	J.D.A.H



TEL: (+57 4) 4 44 74 41
Cr. 48C # 100 Sur - 72
La Estrella - Antioquia
www.elicogrp.com

CONTIENE:	LISTADO DE BORNERAS
PROYECTO:	AUTOMATIZACIÓN SILOS
CLIENTE:	SOCIEDAD PORTUARIA SANTA MARTA

IMPRESO: 20 marzo 2020	
LISTADO DE BORNERAS_K5	
ANTERIOR: K4	#ORDEN: 0120004
ESQUEMA: K5	#REVISIÓN: 1
SIGUIENTE:	TOTAL HOJAS: 20